

Art Deco Series

◆ DIAMOND COLLECTION

STAIR PARTS • LEGS • COLUMNS



Art Deco Series

The Art Deco Series is part of our **Diamond Collection**, designed and manufactured by Oak Pointe includes familiar & new products for stairways but with Oak Pointe's typical expanded options including parts for fireplaces, columns, kitchens and more. All components in this collection are for *interior use only*.

Art Deco Series
DIAMOND COLLECTION



Kitchen Island Column



Pin Top Newel



Square Top Balusters



Estate Newel



Post to Post Newel

MADE IN THE USA ★★

Suggested Handrails: To complement Art Deco Series stair parts. For more selections of flat bottom and plowed handrails, see pages 263-265 in our catalog Edition 3.0.



6109



6210



6310



6400



6910

Newel Dimensions

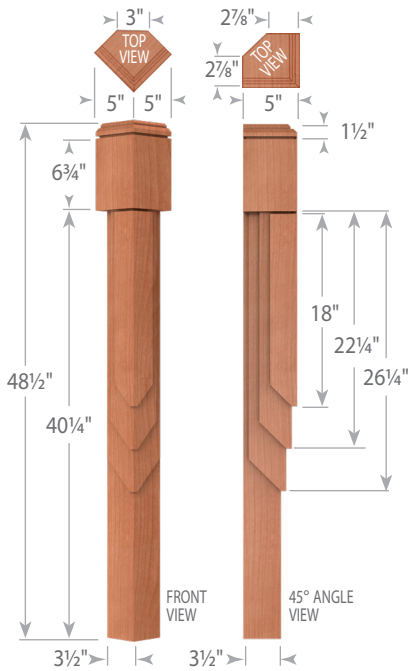

Post to Post Estate Newel

4039-350



Pin Top Newel

Model	(L)
4810-400	43"
4814-400	50"
4815-400	58"

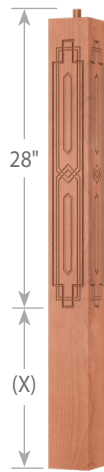

Pin Top Newel

Model	(L)	(X)
-AD5	43"	15"
-AD5	50"	22"
-AD5	58"	30"



Pin Top Newel

Model	(L)	(X)
-AD6	43"	15"
-AD6	50"	22"
-AD6	58"	30"

3/8" Radius Top Edge



Post to Post Newel

4840-400

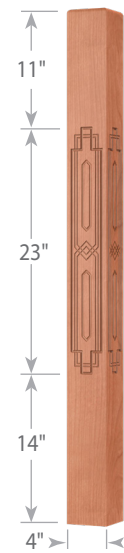

Post to Post Newel

4840-400-AD5



Post to Post Newel

4840-400-AD6

Art Deco Stringer Bracket

(shown in staircase on previous page)



SB100

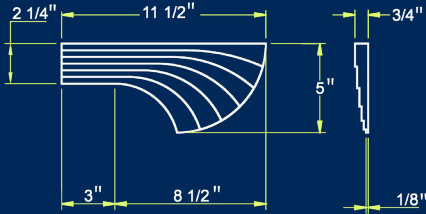

Appliques

Use with any Art Deco Newel



APP100

APP110

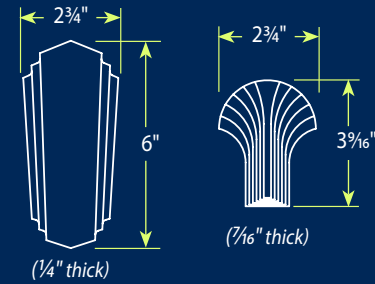

Milling Options	Art Deco 5	Art Deco 6
Code	AD5	AD6

Kitchen Island Column Dimensions

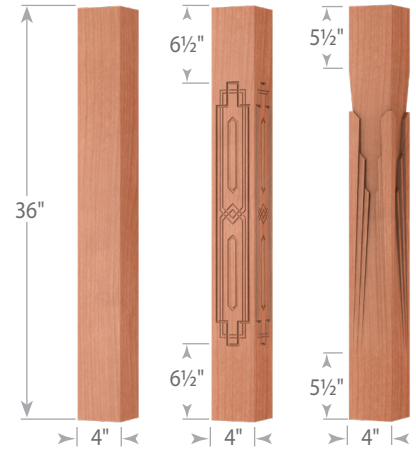

14840-400

14840-400-AD5

14840-400-AD6

Art Deco was an influential visual arts design style that first appeared in France just before World War I and began flourishing internationally in the 1920s, 1930s and 1940s. Oak Pointe is restoring the nostalgia of the roaring 20's appeal into the 2020's with our Art Deco Series of stair parts and accents.

Newel Dimensions

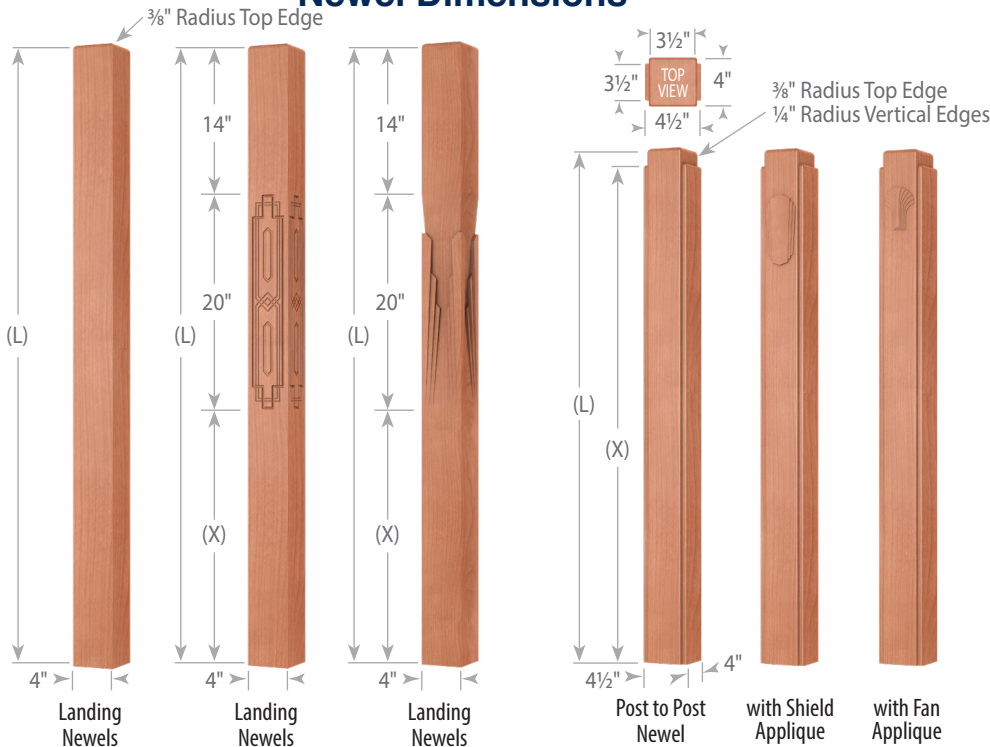

Model	(L)	Model	(L)	(X)	Model	(L)	(X)
2nd Floor 4845-400	58"	-AD5	58"	24"	-AD6	58"	24"
Intermediate 4846-400	73"	-AD5	73"	39"	-AD6	73"	39"

Model	(L)	(X)
4030-450X400	48"	46 1/2"
4032-450X400	58"	56 1/2"
4035-450X400	73"	71 1/2"

Note: All 4 sides have 3" flats for rail

Milling Option Detail



-AD5

-AD6

Milling Options	Art Deco 1	Fluted Deco	Art Deco 1 Fluted Deco	Radius Edges
Code	AD1	FD	AD1-FD	RE

5360-175 Square Balusters

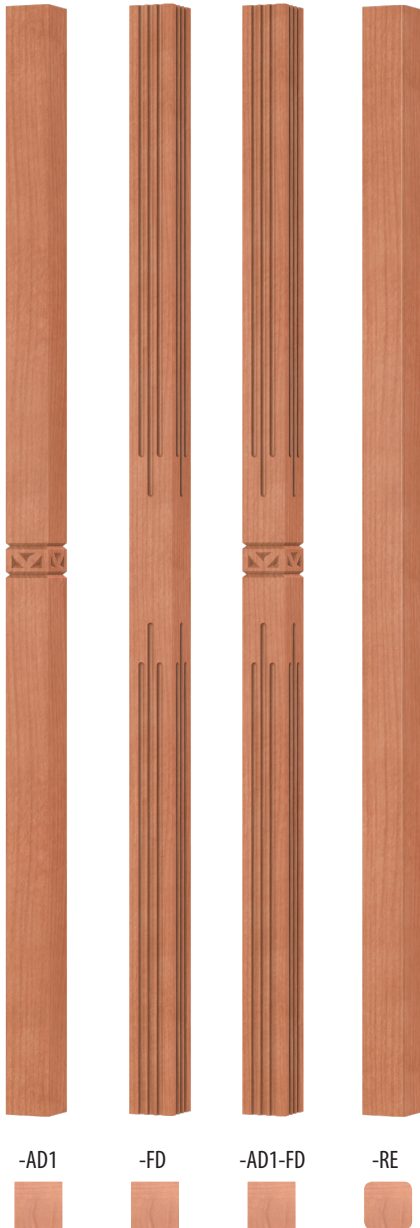

5360R-175x125 Rectangular Balusters



Baluster Dimensions

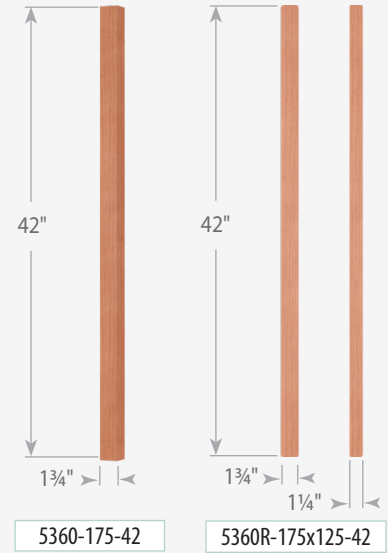

Wooden Dowel Pin

The bottom of each 3 length baluster is drilled and shipped with a loose wooden pin for installation. Optional steel dowel screws also available. Order #3076-100PK (pack of 100).

Narrow side of Rectangular Balusters detailing milling options



Common to Extraordinary Stair Parts, Columns and other Millwork

Stair Parts

Iron Balusters

Stainless Steel

Cable & Glass Systems

Table Legs, Pedestals & Bun Feet

Island & Fireplace Columns

Tapered & No Tapered Columns

Columns for any Application

Finials & Carvings

Corbels & Mouldings

Novelty Items & Store Fixtures

Custom & Large Turnings

Interior & Exterior Applications

... and MORE!



www.StairPartsandMore.com

96 New Pace Road | Newcomerstown, Ohio 43832

P 740.498.9820 | F 740.498.9821

quotes@stairpartsandmore.com | orders@stairpartsandmore.com

Connect with us on:

