

# Arts & Crafts Series

• CLASSIC COLLECTION

STAIR PARTS • LEGS • COLUMNS



## Arts & Crafts Series

The Arts & Crafts Series is part of our **Classic Collection**, designed and manufactured by Oak Pointe includes familiar & new products for stairways but with Oak Pointe's typical expanded options including parts for fireplaces, columns, kitchens and more. All components in this collection are for *interior use only*.

Arts & Crafts Series  
CLASSIC COLLECTION

Chamfered (C) milling option shown

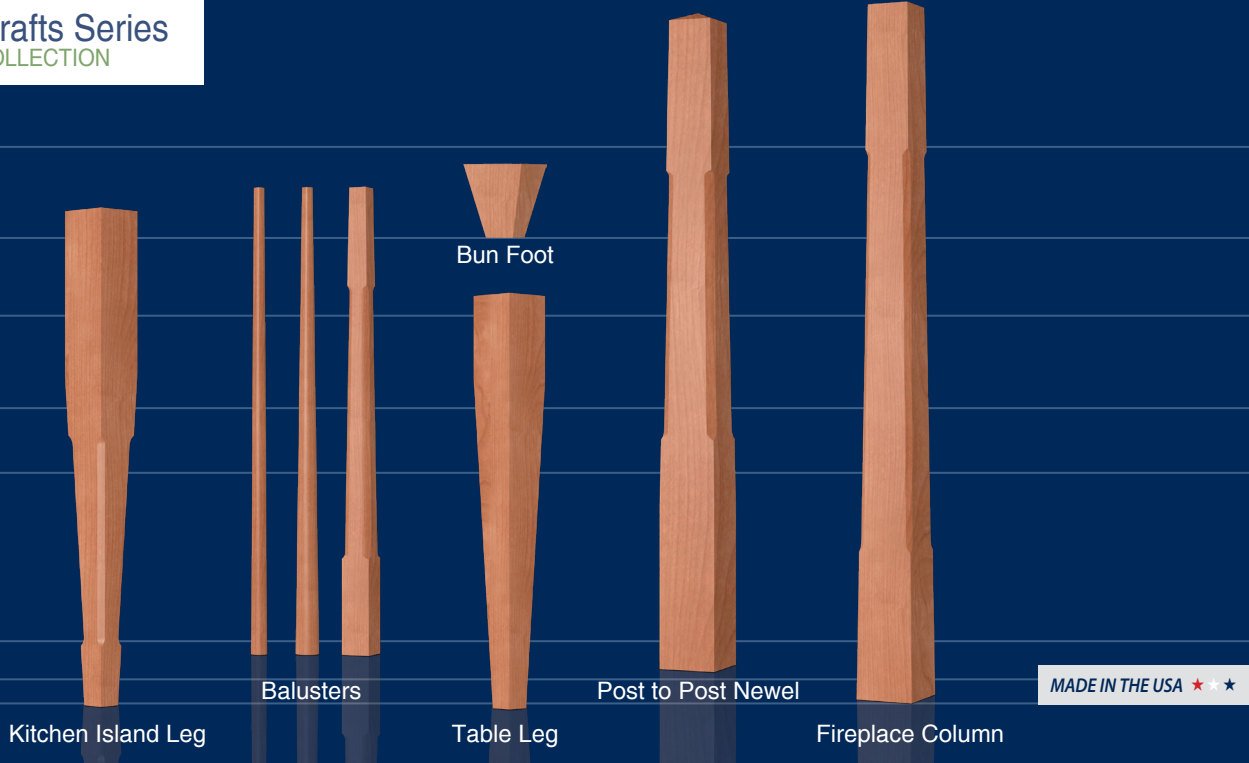

Suggested Handrails: To complement Arts & Crafts Series stair parts. For more selections of flat bottom and plowed handrails, see pages 263-265 in Catalog 3.0.



Newel Dimensions

Model	(L)	(X)
4170-350	43"	15 1/4"
4174-350	50"	22 1/4"
4175-350	58"	30 1/4"
4177-350	73"	45 1/4"
4178-350	78"	50 1/4"

Model	(L)	(NT) No Taper
4002T-400	48"	12"
4003T-400	58"	22"
4219T-400	73"	37"
4220T-400	78"	42"

Model	(L)	(NT) No Taper
4002T-400-C	48"	12"
4220T-400-C	78"	42"

Model	(L)	(NT) No Taper
4003T-400-C	58"	22"
4219T-400-C	73"	37"

See more Square Tapered Box Newels and all Box Newels on pages 31-55 of our catalog Edition 3.0.

Post to Post Newels come with Pyramid Top.

### Baluster Dimensions

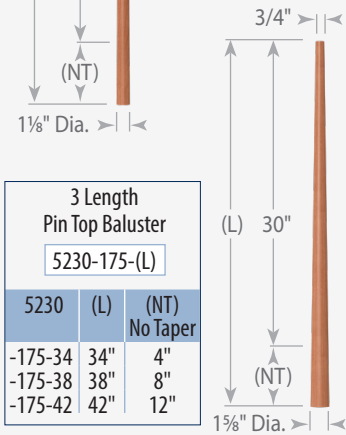
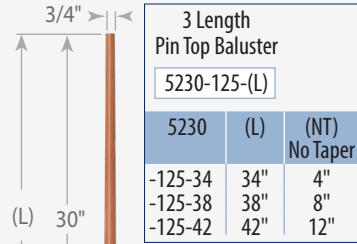

3 Length Square Top Baluster			
5360T-200-(L)			
5360T	(L)	(NT) No Taper	(X)
-200-34	34"	7"	6 1/2"
-200-38	38"	11"	10 1/2"
-200-42	42"	15"	14 1/2"

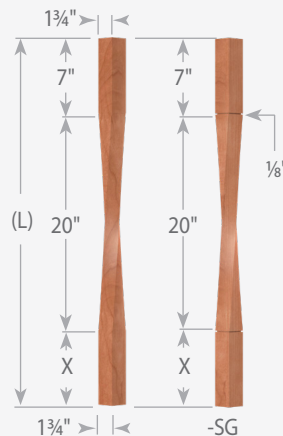
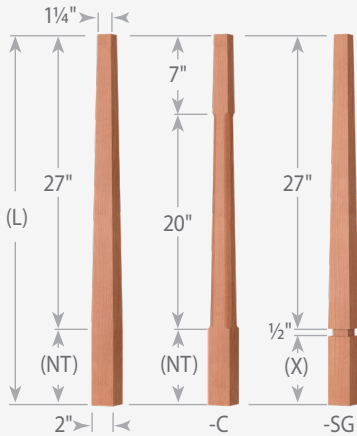

3 Length Square Top Baluster		
5360-175-(L)-RIB1		
5360	(L)	(X)
-175-34	34"	7"
-175-38	38"	11"
-175-42	42"	15"

Milling Options	Chamfered	Ribbon 1	Square Groove
Code	C	RIB1	SG

### Pin Top Balusters

5230-125 (1 1/8" dia.)    5230-175 (1 5/8" dia.)



Plain



Plain



Plain



-C



-SG

### 5360T-200 (2" wide) Square Top Balusters

### 5360-175 (1 3/4" wide) Square Top Balusters



-RIB1



-RIB1-SG



#### Wooden Dowel Pin

The bottom of each 3 length baluster is drilled and shipped with a loose wooden pin for installation. Optional steel dowel screws also available. Order #3076-100PK (pack of 100).

See page 22 of our catalog Edition 3.0 for 3 Length Baluster orientation on treads.

2-Sides Tapered  
Legs & Island Columns

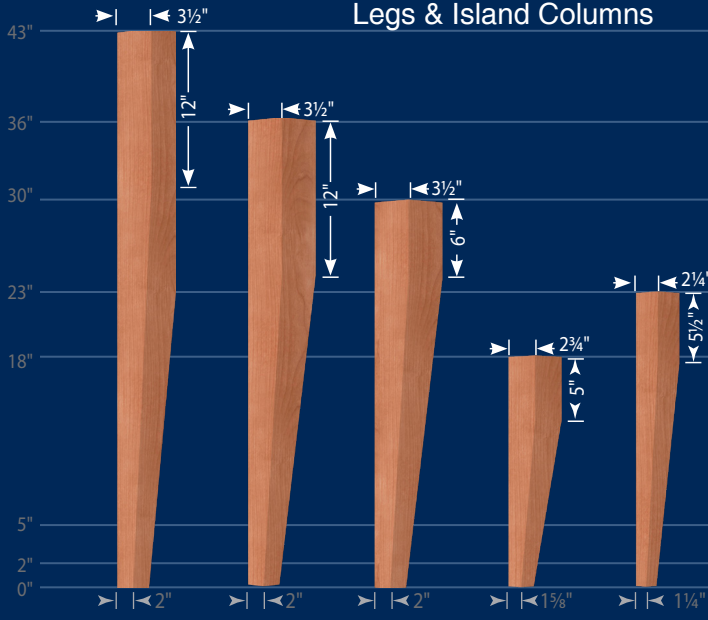

Bar Leg 121052-350  
Island Leg 101052-350  
Table Leg 91052-350  
Coffee Table Leg 81052-275  
End Table Leg 71052-225

4-Sides Tapered  
Legs & Island Columns

\*Chamfered milling option available

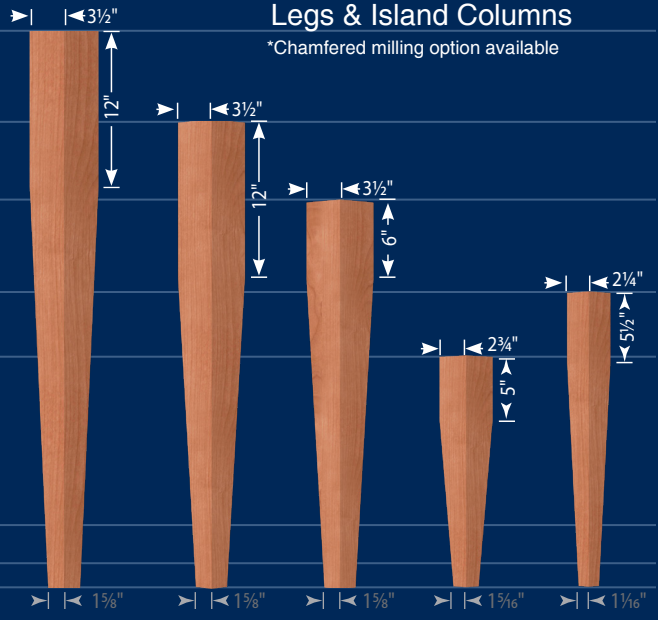

Bar Leg 121054-350  
Island Leg 101054-350  
Table Leg 91054-350  
Coffee Table Leg 81054-275  
End Table Leg 71054-225

Bun Feet

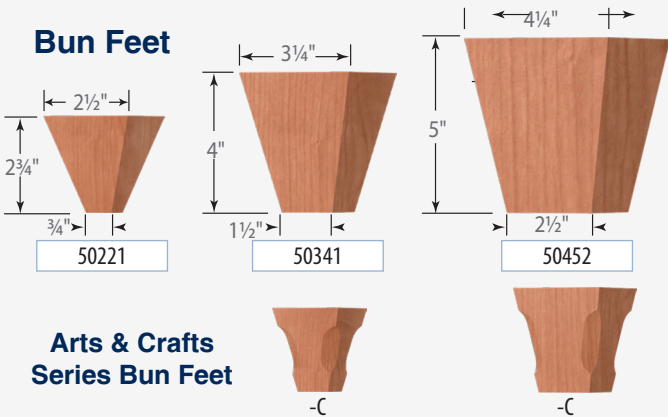

Arts & Crafts  
Series Bun Feet

For more Bun Feet selections, see pages  
298-299 in our catalog Edition 3.0.

Columns, Legs and Bun Feet Milling Options

MILLING OPTIONS	CODE	Legs	Bun Feet	Interior Post	Fireplace Column	Decorative Column
Chamfered	C	3*	3**	3	3	

\* taper - 4 sided legs \*\* except 50221

Milling  
Options  
Details

Name	Chamfered
Code	C

Island Leg  
Example

101054-350-C

Fireplace Columns

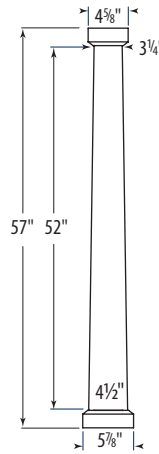

with optional Mission Cap  
and Base

Mission Cap

use Model No. BASEMIS325

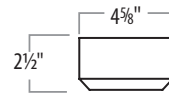

Mission Base

Model No. BASEMIS450

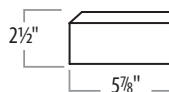

See pages 316-319 in our  
catalog Edition 3.0 for more  
Fireplace Columns



Fireplace Column Example

25360T-450-C

Interior Posts

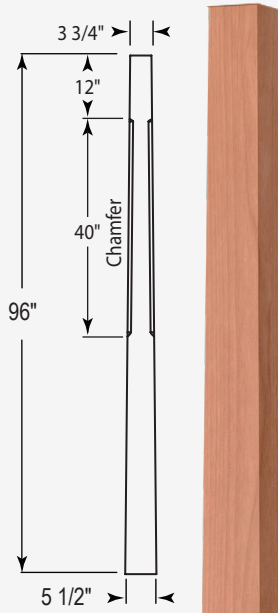

Standard post size is 5 1/2" wide and 96" high.

Interior Post  
Shown Plain

45360T-550

Our columns and posts have not been tested for their weight bearing ability and therefore are sold as NON-weight bearing.

NOTE: These columns are manufactured from solid blanks with face and edge grain.

Decorative Square Tapered Hollow Columns

Square Tapered Hollow Column Dimensions*					
Column Size	1000	1025	1200	1400	1600
Bottom Width "A"	10"	10 1/4"	12"	14"	16"
Top Width "B"	5 1/2"	7 1/2"	10"	12"	9"
Standard Lengths (including cap & base)	66"	7'	6', 10'	9'	58", 6', 8'
Cap & Base Included	Mission Cap/Base				

\*Dimensions shown are after final field trimming of shaft bottom using Mission Cap/Base.

Mission Base/Cap Dimensions					
Column Size	1000	1025	1200	1400	1600
Mission Base bottom square width "C"	6 7/8"	8 7/8"	11 3/8"	13 3/8"	10 3/8"
Mission Base bottom square width "CC"	11 3/8"	11 3/8"	13 3/8"	15 3/8"	17 3/8"

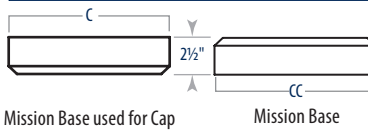

Tuscon Base/Cap Dimensions					
Column Size	1000	1025	1200	1400	1600
Tuscon Base bottom square width "C"	9"	11"	13 1/2"	15 1/2"	12 1/2"
Tuscon Base bottom square width "CC"	13 1/2"	13 3/4"	15 1/2"	17 1/2"	19 1/2"

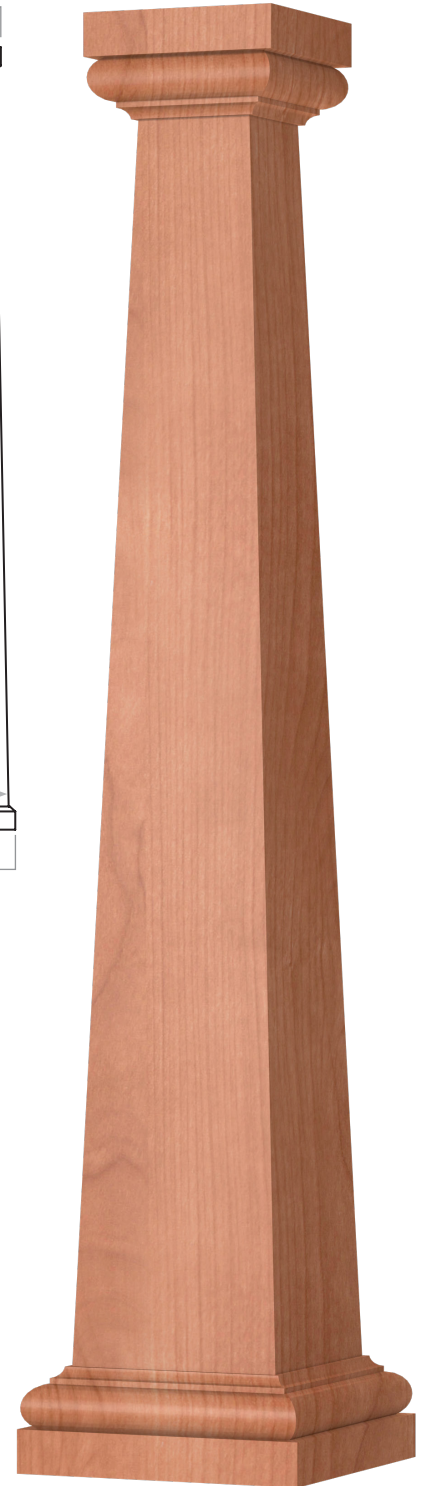
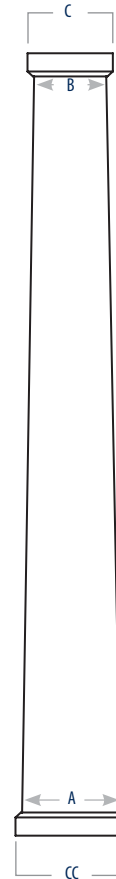
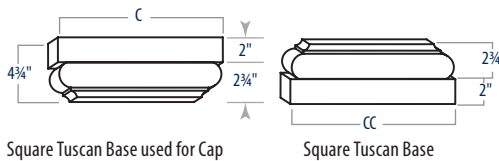

10" x 66"  
Arts & Crafts Series Column with optional Tuscon Cap and Base

35360T-1000x550-66

Examples of Mission Caps  
(with optional Neck Molds mitered and applied in field)

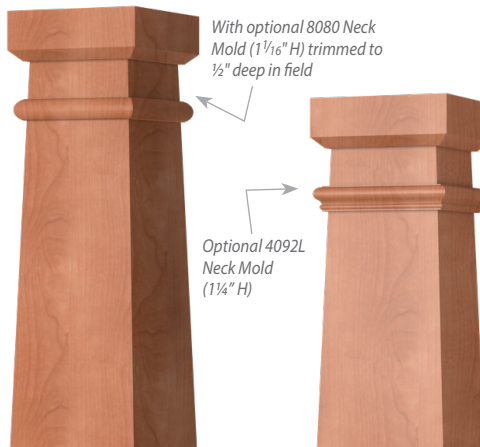

See our full catalog pages 310-315 in our catalog Edition 3.0 for more Columns

# *Common to Extraordinary* Stair Parts, Columns and other Millwork

Stair Parts

Iron Balusters

Stainless Steel

Cable & Glass Systems

Table Legs, Pedestals & Bun Feet

Island & Fireplace Columns

Tapered & No Tapered Columns

Columns for any Application

Finials & Carvings

Corbels & Mouldings

Novelty Items & Store Fixtures

Custom & Large Turnings

Interior & Exterior Applications

... and MORE!



[www.StairPartsandMore.com](http://www.StairPartsandMore.com)

96 New Pace Road | Newcomerstown, Ohio 43832

P 740.498.9820 | F 740.498.9821

[quotes@stairpartsandmore.com](mailto:quotes@stairpartsandmore.com) | [orders@stairpartsandmore.com](mailto:orders@stairpartsandmore.com)

Connect with us on:

