

# Colonial Series

• CLASSIC COLLECTION

STAIR PARTS • LEGS • COLUMNS



## Colonial Series

The Colonial Series is part of our **Classic Collection**, designed and manufactured by Oak Pointe includes familiar & new products for stairways but with Oak Pointe's typical expanded options including parts for fireplaces, columns, kitchens and more. All components in this collection are for *interior use only*.

Colonial Series  
CLASSIC COLLECTION



Kitchen Island Column



Balusters



Bun Foot



Table Leg



Post to Post Newel



Fireplace Column

MADE IN THE USA ★★

**Suggested Handrails:** To complement Colonial Series stair parts. For more selections of flat bottom and plowed handrails, see pages 263-265 in our catalog Edition 3.0.



6010



6210



6310



6601

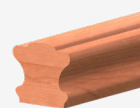

9500

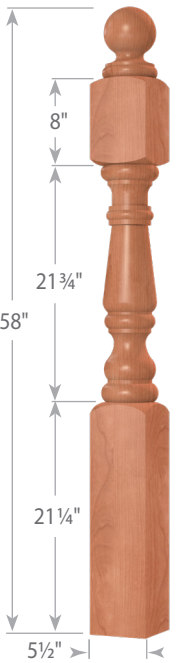

Post to Post Estate Newel

4160-550

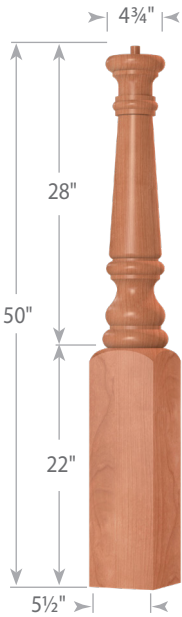

Pin Top Estate Newel

4016-550

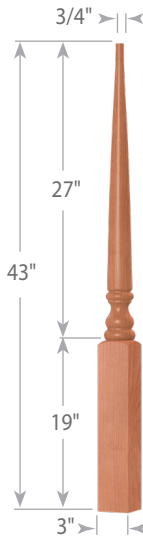

Pin Top Rake Newel

4013-300

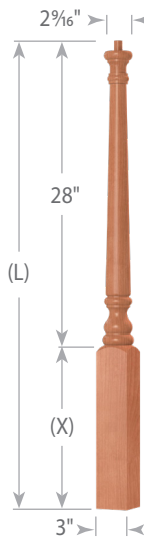

Pin Top Newel

Model	(L)	(X)
4010-300	43"	15"
4014-300	50"	22"
4015-300	58"	30"
4017-300	65"	37"
4018-300	73"	45"

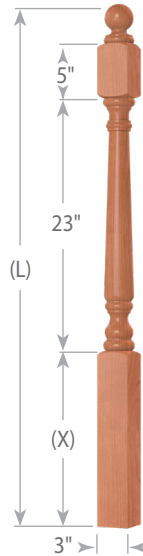

Post to Post Newel

Model	(L)	(X)
4150-300	48"	16"
4152-300	58"	26"
4163-300	62"	30"
4165-300	73"	41"
4168-300	78"	46"

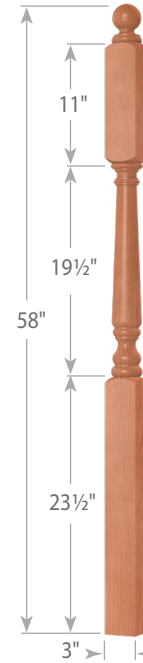

2nd Floor Landing Newel

4155-300

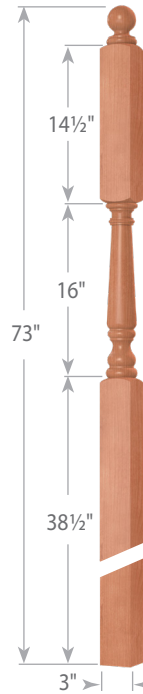

Intermediate Landing Newel

4156-300

Newel Dimensions

More Colonial 3 1/4" Newels on next page

Post to Post Newels shown with Ball Top (BT). See all Post Top options on pages 300-302 in our catalog Edition 3.0.

## Baluster Dimensions

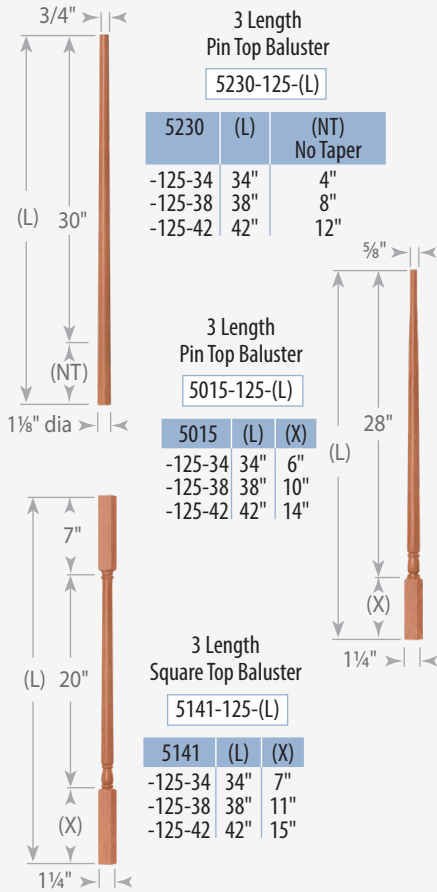

### Wooden Dowel Pin

The bottom of each 3 length baluster is drilled and shipped with a loose wooden pin for installation.

See page 22 in our catalog Edition 3.0 for 3 Length Baluster orientation on treads

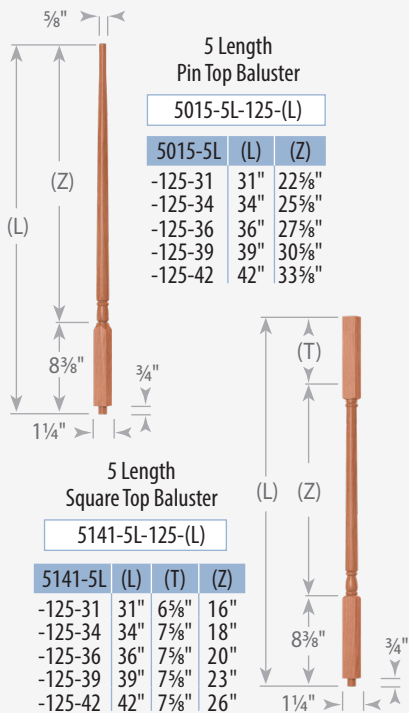

See page 22 in our catalog Edition 3.0 for 5 Length Baluster orientation on treads

Milling Options	Fluted	Reeded
Code	F	R

Colonial Series  
CLASSIC COLLECTION

## Square Top Balusters

5141-125  
(1 1/4" wide)

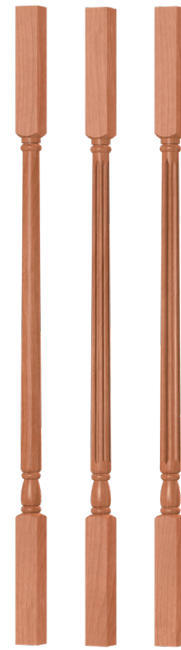

Plain -F -R

## Pin Top Balusters

5015-125  
(1 1/4" wide)



Plain -F -R

5230-125  
(1 1/8" dia.)



Plain -F -R

5230-175  
(1 5/8" dia.)



Plain

See page 133 in our catalog Edition 3.0 for more details

## Newel Dimensions

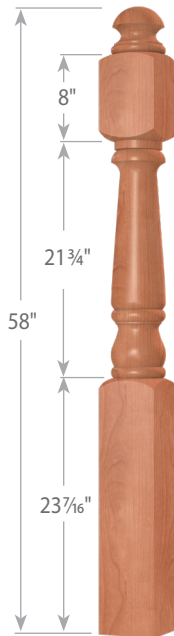

Post to Post  
Estate Newel

4190-550

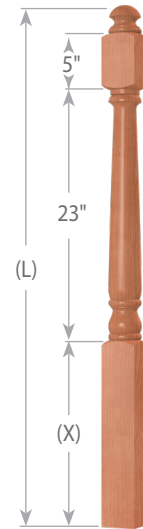

Post to Post  
Newel

Model	(L)	(X)
4180-325	48"	17"
4182-325	58"	27"
4193-325	62"	31"
4195-325	73"	42"
4198-325	78"	47"

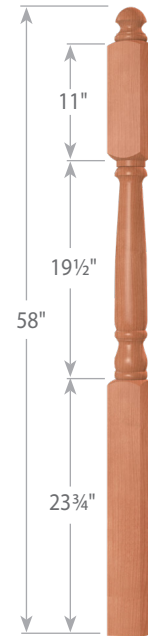

2nd Floor  
Landing Newel

4185-325

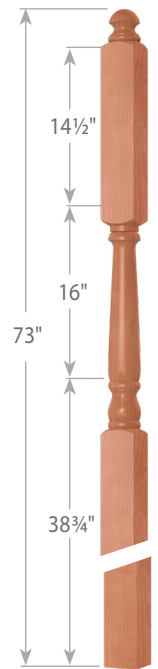

Intermediate  
Landing Newel

4186-325

Post to Post Newels shown with Mushroom Top (MT). See all Post Top options on pages 300-302 in our catalog Edition 3.0.

### Legs and Island Columns

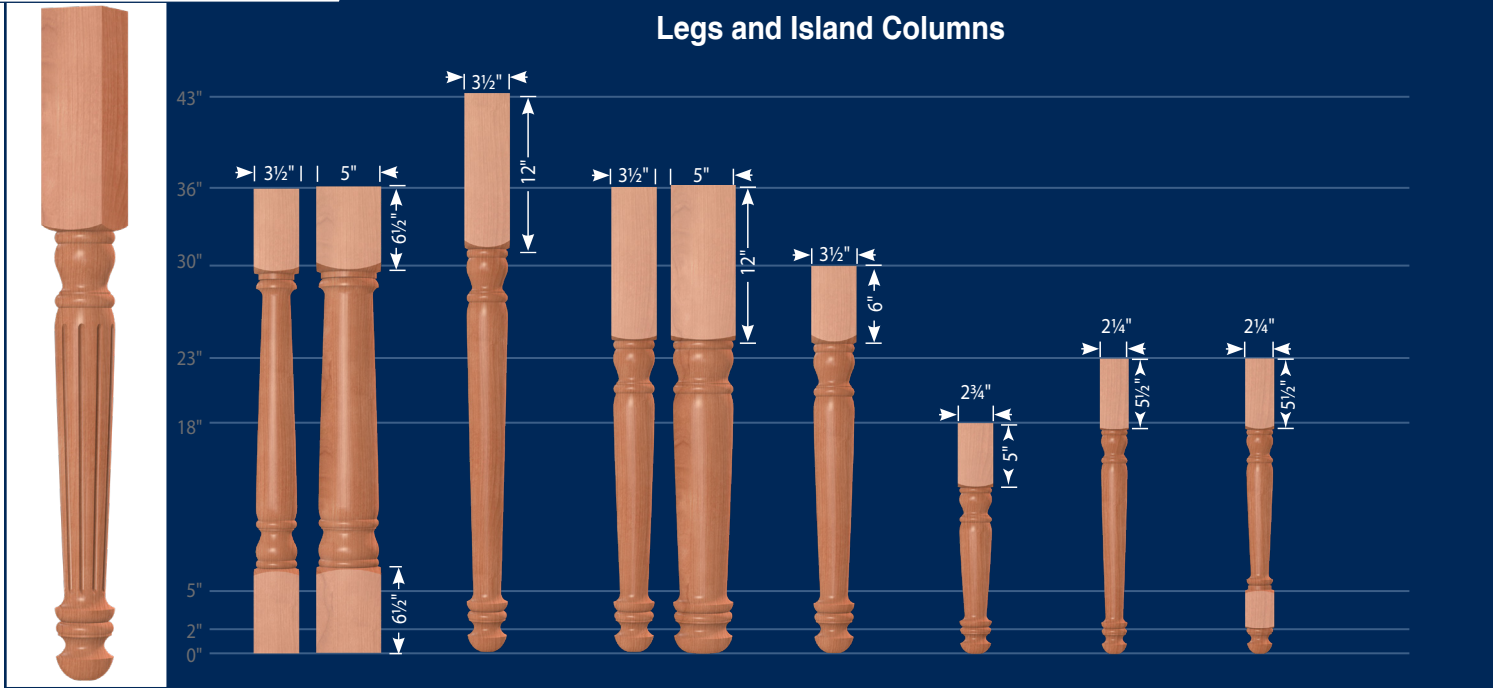

Island Leg Example 105015-350-F	Island Column 15015-350 15015-500	Bar Leg (Footed) 125015-350	Island Leg (Footed) 105015-350 105015-500	Table Leg (Footed) 95015-350	Coffee Table Leg (Footed) 85015-275	End Table Leg (Footed) 75015-225	End Table Leg (w/stretcher block) 65015-225
------------------------------------	---	--------------------------------	---	---------------------------------	--	-------------------------------------	--

### Bun Feet



### Columns, Legs and Bun Feet Milling Options

MILLING OPTIONS	CODE	Island Column	Legs	Bun Feet	Interior Post	Fireplace Column	Decorative Column
Fluted	F	✓	✓	✓	✓	✓	✓
Fluted Sunburst	F1			✓			
Reeded	R	✓	✓	✓	✓	✓	✓
Twist	TW			✓			

Milling Options Details	Fluted	Reeded
Name	Fluted	Reeded
Code	F	R



### Interior Posts

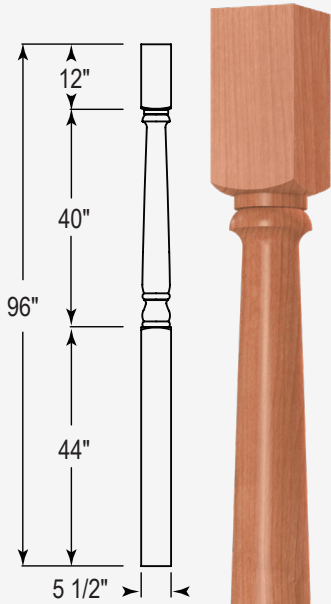

Standard post size is 5 1/2" wide and 96" high.

Interior Post Shown Plain

45015-550

Our columns and posts have not been tested for their weight bearing ability and therefore are sold as NON-weight bearing.

### Fireplace Columns

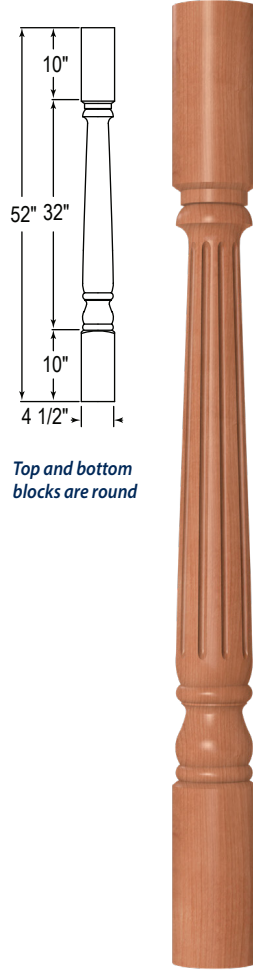

Top and bottom blocks are round

Fireplace Column Example

25015-450-F

### Tuscan Base

used for Cap and Base (optional)



Model No. BASETUS450

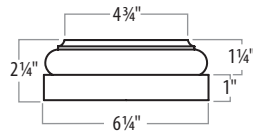

Fireplace columns shown with Fluted milling option.

See pages 316-319 in our catalog Edition 3.0 for more Fireplace Columns

### Decorative Solid Round Columns

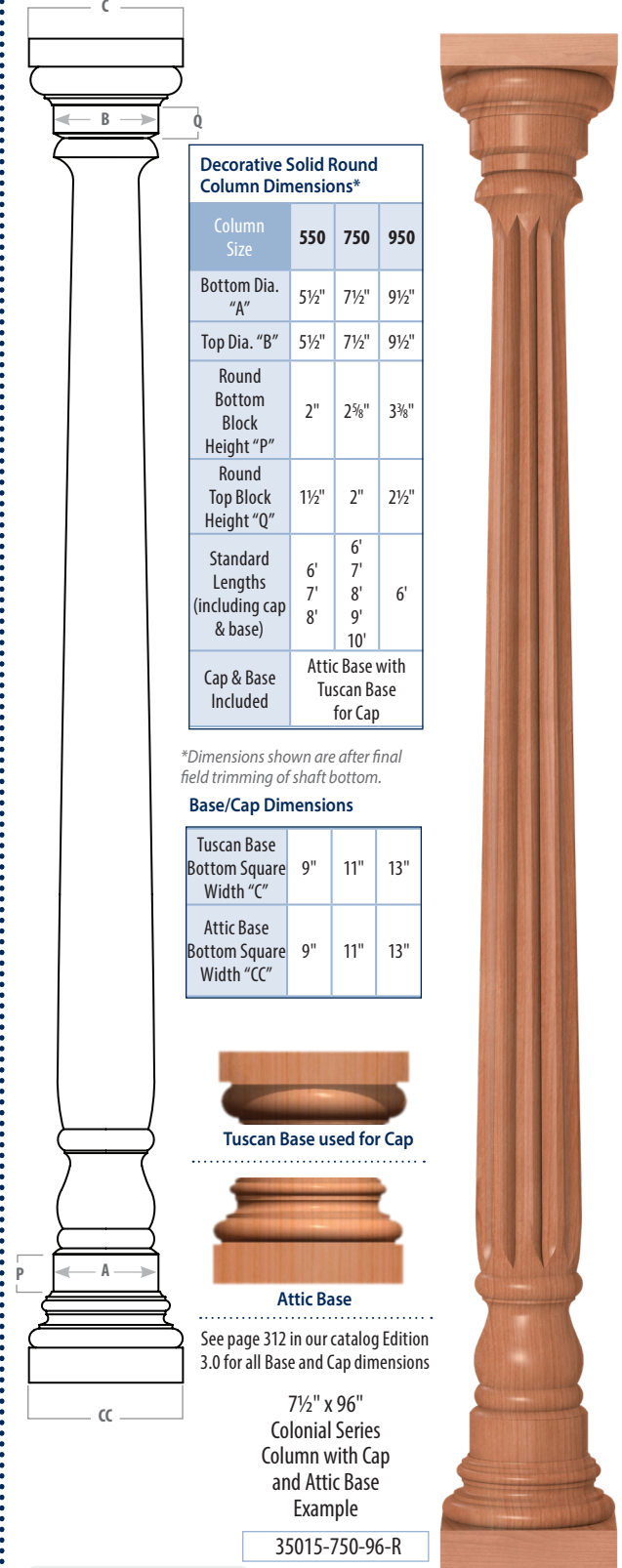

#### Decorative Solid Round Column Dimensions\*

Column Size	550	750	950
Bottom Dia. "A"	5 1/2"	7 1/2"	9 1/2"
Top Dia. "B"	5 1/2"	7 1/2"	9 1/2"
Round Bottom Block Height "P"	2"	2 3/8"	3 3/8"
Round Top Block Height "Q"	1 1/2"	2"	2 1/2"
Standard Lengths (including cap & base)	6' 7' 8'	6' 7' 8' 9' 10'	6'
Cap & Base Included	Attic Base with Tuscan Base for Cap		

\*Dimensions shown are after final field trimming of shaft bottom.

#### Base/Cap Dimensions

Tuscan Base Bottom Square Width "C"	9"	11"	13"
Attic Base Bottom Square Width "CC"	9"	11"	13"



Tuscan Base used for Cap



Attic Base

See page 312 in our catalog Edition 3.0 for all Base and Cap dimensions

7 1/2" x 96"  
Colonial Series  
Column with Cap  
and Attic Base  
Example

35015-750-96-R

NOTE: These columns are manufactured from solid blanks with face and edge grain.

See pages 310-315 in our catalog Edition 3.0 for more Columns

# *Common to Extraordinary* Stair Parts, Columns and other Millwork

Stair Parts

Iron Balusters

Stainless Steel

Cable & Glass Systems

Table Legs, Pedestals & Bun Feet

Island & Fireplace Columns

Tapered & No Tapered Columns

Columns for any Application

Finials & Carvings

Corbels & Mouldings

Novelty Items & Store Fixtures

Custom & Large Turnings

Interior & Exterior Applications

... and MORE!



[www.StairPartsandMore.com](http://www.StairPartsandMore.com)

96 New Pace Road | Newcomerstown, Ohio 43832

P 740.498.9820 | F 740.498.9821

[quotes@stairpartsandmore.com](mailto:quotes@stairpartsandmore.com) | [orders@stairpartsandmore.com](mailto:orders@stairpartsandmore.com)

Connect with us on:

