



# BOX NEWELS

SQUARE • OCTAGON • TAPERED • ESTATE • BOX COLUMNS



★ ★ ★ *MADE IN THE USA* ★ ★ ★

Our **Box Newel Collection**, designed and manufactured by Oak Pointe, features the most extensive standard offering of box newels found anywhere. All of our box newels are handcrafted using lock miter joints, solid face grain sides and stile & rail construction with true floating panels. All components in this collection are for interior use only.

**WHERE TRADITION AND INNOVATION CREATE EXCELLENCE**

Custom components are an integral part of our business. Call for pricing on your designs for interior and exterior use.



# The Anatomy of Our Box Newels

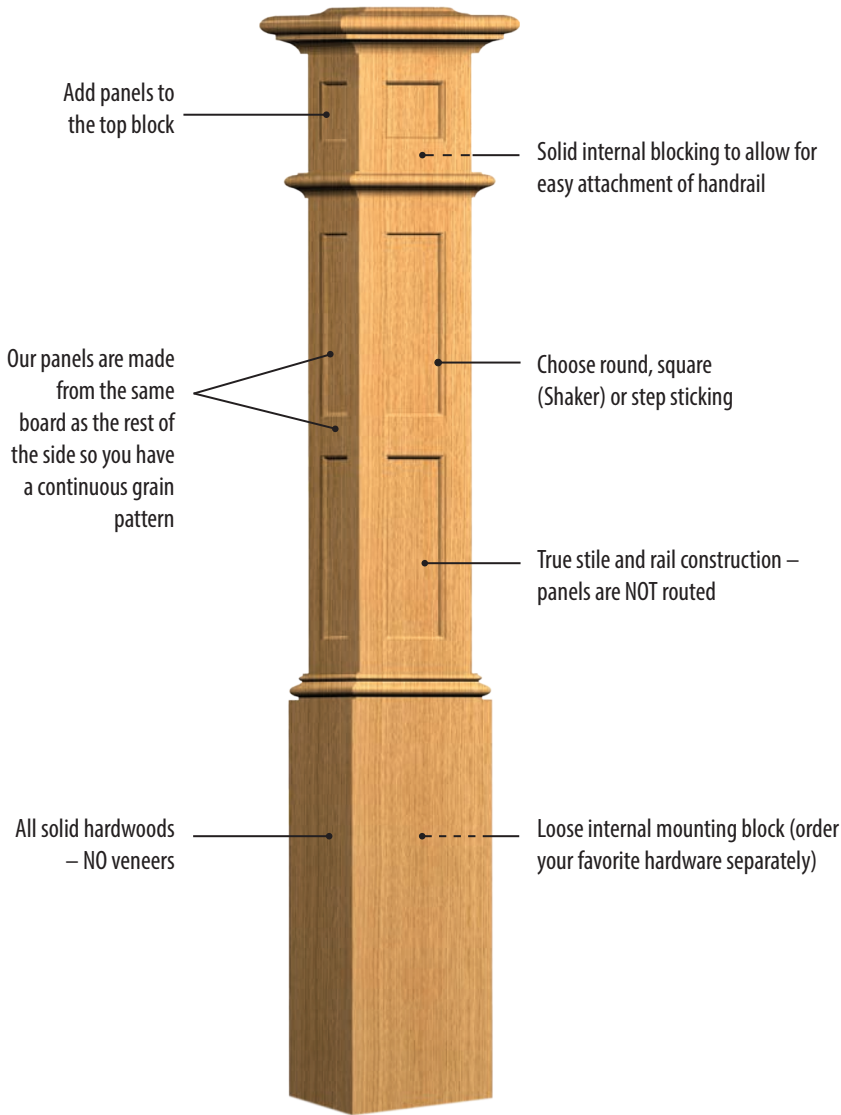

## Cross Sections of Box Newels with Panels

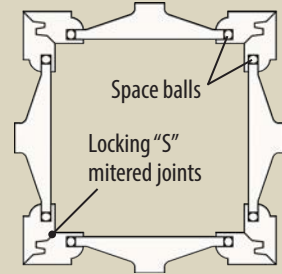

True floating panels

Note: Space balls allow for normal expansion and contraction

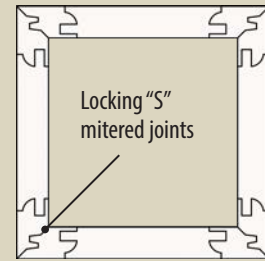

True stile and rail construction

## Cross Section of Plain or Milled Box Newel

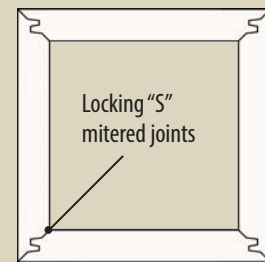

**Products included in installation from the previous page large image:**

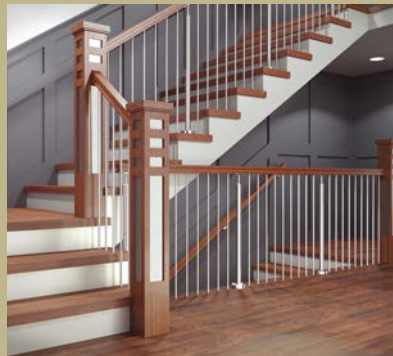

- Box newels- 4660 with B, B1 & B custom sides and stainless steel panels  
(see pages 58-61 in our catalog Edition 4.0)
- Handrail- 9200  
(see page 237 in our catalog Edition 4.0)
- Balusters- 1/2" round stainless steel  
(see page 211 in our catalog Edition 4.0)
- Stainless Steel Newels- Round Series 1½" diameter  
(see page 212 in our catalog Edition 4.0)



Stairway pictured with 4092-FP-SS-3 with 7917 cap, cove molding and FINIAL-FLA (Flame Top Finial), 6910 multi-species rail, 4291-FP-SS-290 and 4291-FP-SS-2180, some with long bases and pyramid newel drops and all with 7917 cap & cove molding. Balusters are Cambridge series 2410, 3 length style.



### ***Box Newel with multi-species***

Change the species on a portion or all of the cap and/or the moldings. On box newels with panels also change the panels (see panel options).





# Standard Box Newels

## Step One...

**Choose your style** Choose from 9 standard or 3 tapered styles...  
or discover our selection of Estate and custom styles.

**4660 / 4661 series**  
*(see pages 58,60-61)*

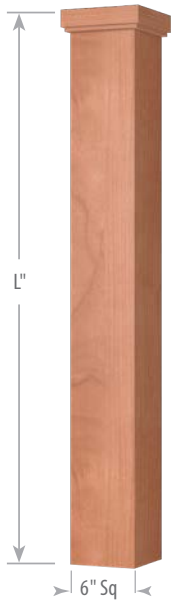

| Model | (L) Length |
|-------|------------|
| 4660  | 48"        |
| 4661  | 58"        |

**4091 series**  
*(see pages 64-65)*

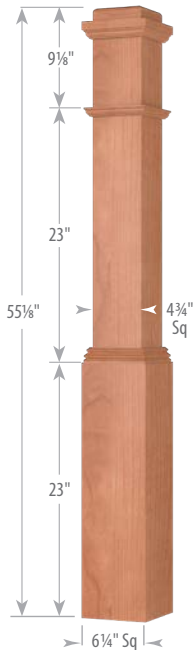

4091

**4291 series**  
*(see pages 70-71)*

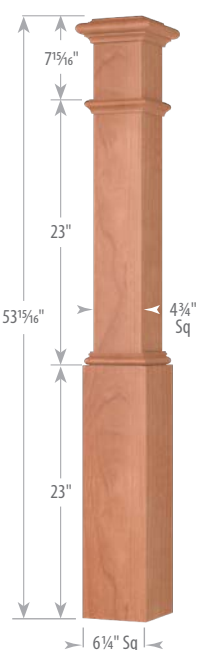

4291

**4092 series**  
*(see pages 72-73)*

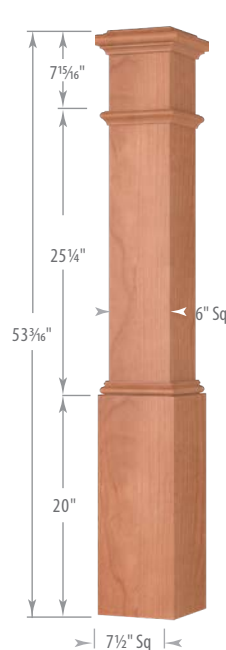

4092

**4292 series**  
*(see pages 66-67)*

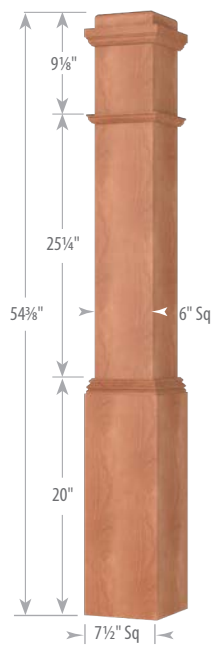

4292

**4630 / 4631 series**  
*(see pages 58-59)*

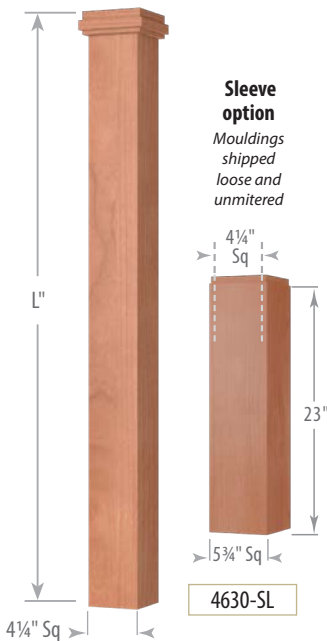

| Model | (L) Length |
|-------|------------|
| 4630  | 48"        |
| 4631  | 58"        |

4630-SL

**4075 series**  
*(see page 63)*

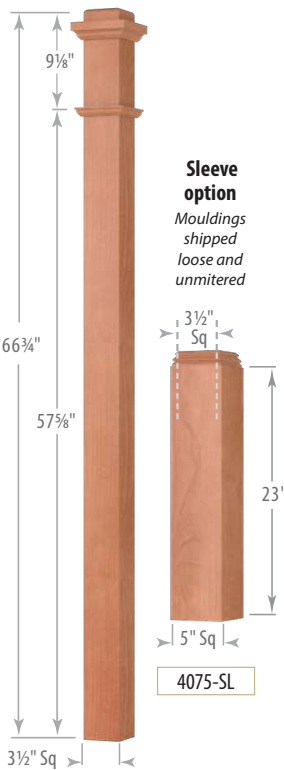

4075

**Sleeve option**  
Mouldings shipped loose and unmitered

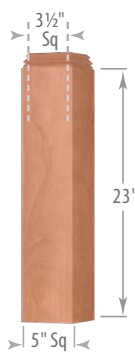

4075-SL

**4076 series**  
*(see page 69)*

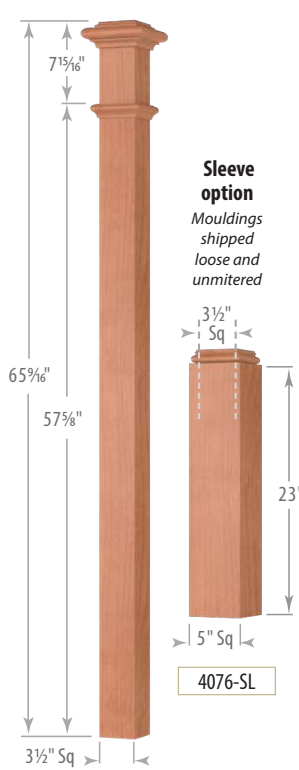

4076

**Sleeve option**  
Mouldings shipped loose and unmitered

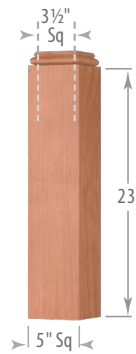

4076-SL

**4392 series**  
*(see pages 74-75)*

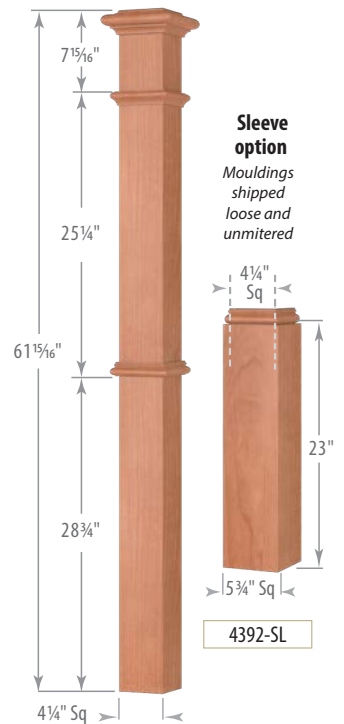

4392

**Sleeve option**  
Mouldings shipped loose and unmitered



4392-SL

## Tapered Box Newels

**4092T series**  
(see page 62)

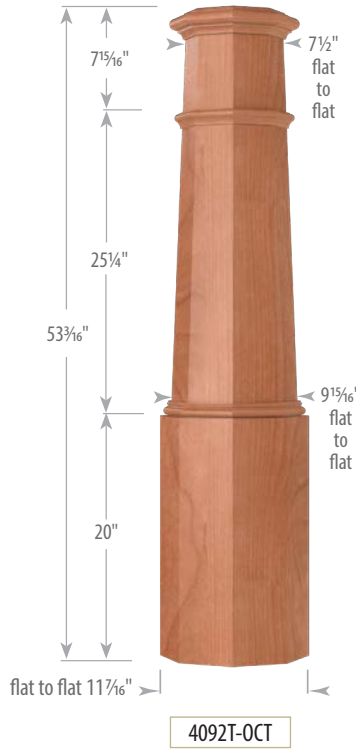
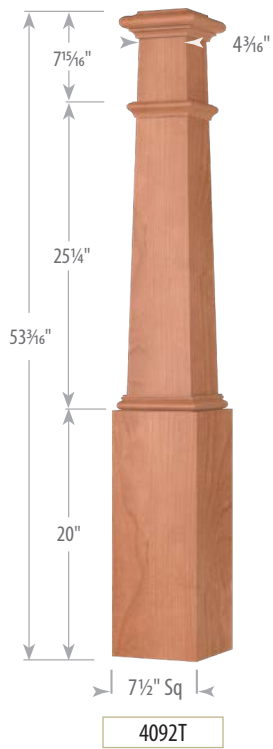

**4293T series**  
(see page 62)



**4294T series**  
(see page 62)

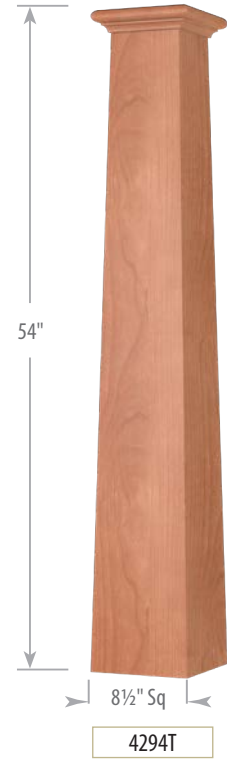

## Estate Box Newels

On these models specify which sides are to have top block panels, carved medallions, or flutes.

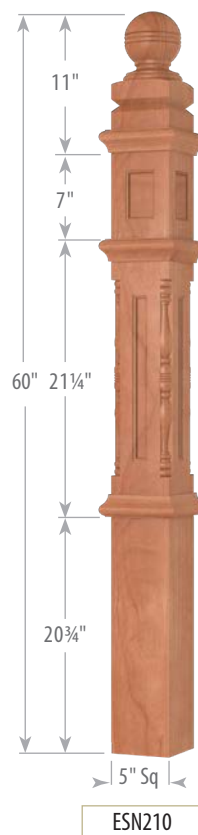
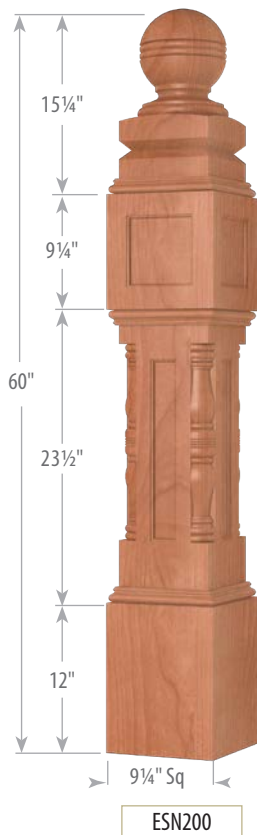
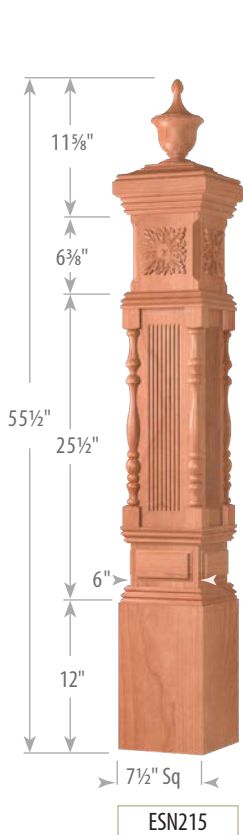



## Step Two...

## Choose your Cap and other options

for 4075, 4091 and 4292 style Box Newels

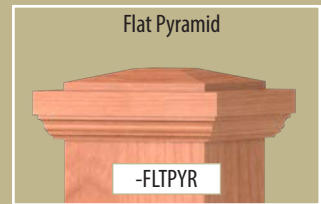
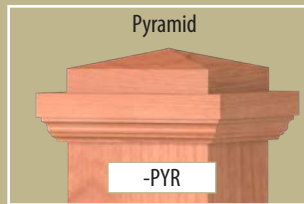
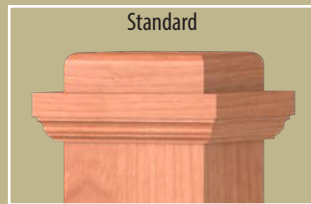

for 4076, 4291, 4392, and 4092 style Box Newels

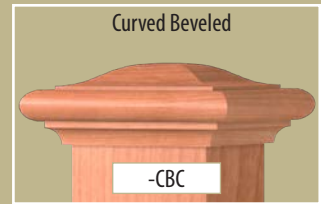
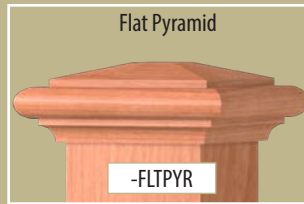
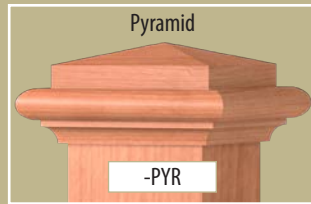

### Box Newels with caps to match your handrail profile



4092-FP shown with 7717 cap & cove molding



6710

xx17 cap- see page 242 in our catalog Edition 4.0 for more options



Add a Finial to your Box Newels

FINIAL-LBT (shown)

### Finial base sizes for standard caps

| Newel Type | Finial max dia. | Newel Type | Finial max dia. |
|------------|-----------------|------------|-----------------|
| 4075       | 2½"             | 4292       | 5"              |
| 4076       | 3"              | 4293T      | 5½"             |
| 4091       | 3¾"             | 4294T      | 5½"             |
| 4092       | 5½"             | 4392       | 3¾"             |
| 4092T      | 3¾"             | 4092T-OCT  | 7½"             |
| 4291       | 4¼"             |            |                 |

See standard Finial designs on pages 276-278 in our catalog Edition 4.0

### Box Newels with Extended Base

**Box Newels with extended bases for side mounting or landing applications**

Please specify your requirements. 4091-FP shown with overall height of 72" and base at 40".



4091-FP shown with extended base

### Box Newels with newel drops



Beautifully cap the bottom of side mounted box newels. Choose our pyramid or flat bottom newel drops.



7½" Sq

4092 shown

Pyramid Bottom Newel Drops

2"

Flat Bottom Newel Drops

2¼"



7½" Sq



### Step Three...

### Add a decorative milling

Available in these models: 4075, 4076, 4091, 4092, 4291, 4292, 4392



#### FLUTED AND V-GROOVED OPTIONS



Close-up of Fluted



Close-up of V-Grooved



-CIR1-F4



-CIR2-F4



-F



-M4L-VG4



-M4R-VG4



-M6C-VG4



-M9-VG4

#### Ordering Examples:

Box Newel Series      Milling Code  
4091      -      M6C-VG4

| Milling Options | Circle 1 Fluted | Circle 2 Fluted | Fluted    | Mission 4 LH V-Grooved | Mission 4 RH V-Grooved | Mission 6 Centered V-Grooved | Mission 9 V-Grooved |
|-----------------|-----------------|-----------------|-----------|------------------------|------------------------|------------------------------|---------------------|
| Code            | <b>CIR1-F4</b>  | <b>CIR2-F4</b>  | <b>F*</b> | <b>M4L-VG4</b>         | <b>M4R-VG4</b>         | <b>M6C-VG4</b>               | <b>M9-VG4</b>       |

\* 4092 Series has 4 flutes per side.



## Step Four...

### Choose a Panel design option

Get your Raised or Flat Panels in a specie different than the main newel or in metal

Get optional Square, Step or Large Sticking with your raised or flat panels

Get your Raised or Flat Straight Top Panels with applied mouldings

### Flat Panel



Straight Top Flat Panel (-FP)



Eyebrow Top Flat Panel (-FP-ET)



Round Top Flat Panel (-FP-RT)

### Raised Panel



Straight Top Raised Panel (-RP)



Eyebrow Top Raised Panel (-RP-ET)



Round Top Raised Panel (-RP-RT)

### Panel Inserts



Stainless Steel Panel (grain runs vertically)



Multi-Specie Panel

## Sticking and Top Block Panel Options

All of our box newel panels are standard with Round Sticking ... order optional Square, Step or Large Sticking.

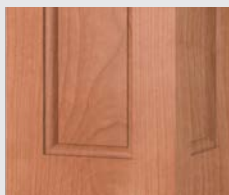

Round Sticking (standard)

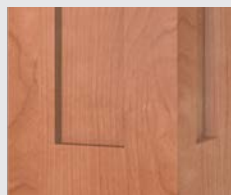

Square Sticking (-SS)

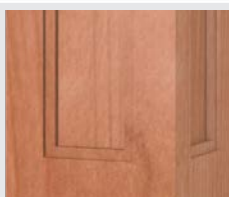

Step Sticking (-SP)

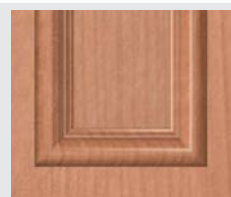

Large Sticking (-LS)

NOTE: Large sticking available only on 4092-FP and 4292-FP (See pages 67 & 73 in our catalog Edition 4.0).

Available on:

- 4630/4631 C Panel
- 4660/4661 C & D Panels
- 4392- FP or RP, but no top panels
- 4091, 4092, 4291 & 4292- FP or RP with or without top panels
- 4092T-FP or RP but no top panels
- 4293T/4294T-FP or RP

**Ordering Information:**  
Add "-SS", "-SP" or "-LS" after product number – e.g. 4092-FP-SS



Top block flat or raised panels have three options available.

- ◆ 2 panels opposite each other (180°)
- ◆ 2 adjacent panels (90°)
- ◆ 3 panels

Ordering Information for additional panels:  
Box Newels with panels come standard with 4 lower panels.  
For optional top panels, add the following after product number:

- 2 Opposite Panels – add part number 2180
- 2 Adjacent Panels – add part number 290
- 3 Panels – add part number 3

4392 Box Newel top block accepts flat panel option only.

e.g. 4392-FP-290 or 4392-FP-SS-290 (with Square Sticking)

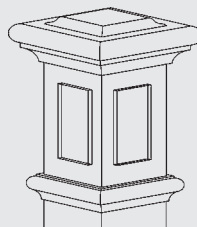

2 Top Panel - 90°

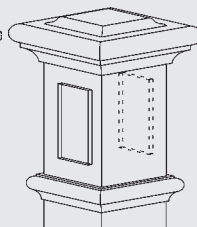

2 Top Panel - 180°

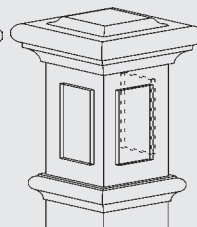

3 Top Panel





4092-RP-2E-3-PM

Example of 4092 series Box Newel with Applied Panel Mouldings

## Applied Panel Mouldings

(approx 5/8" wide x 1/4" thick)



4091-FP-PM

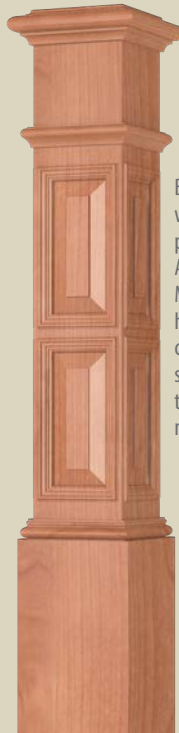

4092-RP-2E-PM

Box Newels with 2 even panels and Applied Panel Mouldings will have wider cross rail and shorter panels to allow for mouldings



4092-RP-PM

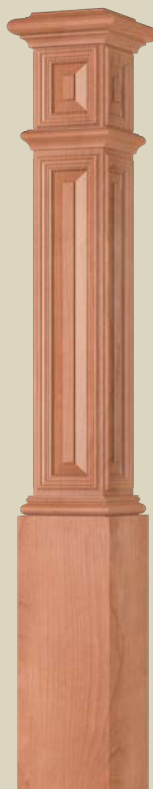

4291-RP-3-PM

Box Newels with panels in the top block and Applied Panel Mouldings will have longer shafts and the top block area will be taller to allow for mouldings

## Panels in Box Newel Bases



Customize your Box Newels with Flat or Raised Panels in the base.

- Indicate if you want panels in 1, 2, 3 or 4 sides.
- Specify your stile & rail sizes.
- With Round Sticking, the dimensions must be minimum 1" and with Square Sticking 1 1/4".

## Long Panel Option



4092-FP-LP

4092 Box Newel with long flat panels in shaft, shown with base field cut to 12" height. Flat Panels on a 4092 box newel can accommodate a handrail up to 3 5/8" wide.

**Oak Pointe's** Contemporary Box Newels come in four sizes and 12 different standard designs to choose from! Flat panel options include:

- *Stainless Steel 304 Satin #4 finish (grain runs vertically)*
- *Wood panel same or different species as the newel*

Get creative and mix them to achieve the look that you desire.

**• Choose your sides**  
(any combination)

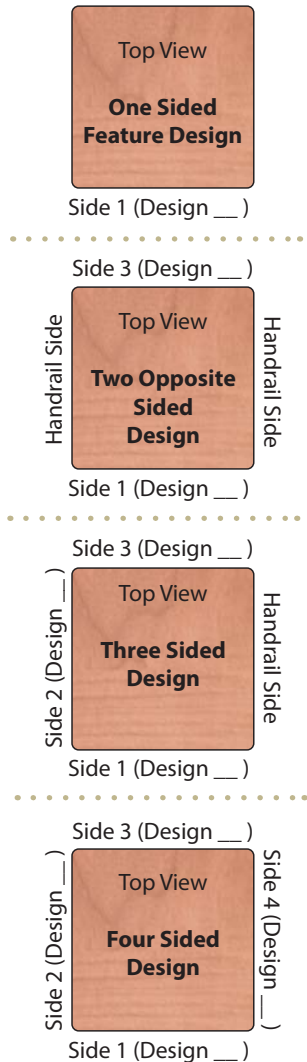

*Examples shown with model 4660 Newels*



**Sleeve option**

Sleeve option for 4630 and 4631 series

*Mouldings shipped loose and unmitered*



**Contemporary Box Newels:** *Standard Oak Pointe features including lock mitered corners, stile & rail construction with true floating panels.\* Upper area has solid internal blocking to allow for easy attachment of handrail. Loose internal bottom mounting block included (order your favorite hardware separately).*

**Endless Combinations Available for Your Custom Creation**

- 4 Box Newel models
- 12 different standard designs
- Choose Box Newel species... then select panel infill between matching, or other wood species, or stainless steel
- Sticking... standard Square Sticking or optional Step Sticking (see page 56)
- Choice of 2 caps  

|                         |                 |
|-------------------------|-----------------|
| -CT<br>Contemporary Top | -FT<br>Flat Top |
|                         |                 |



*\*Design series "C2", "C3", "M", "M1" and "T" non-rectangular panels are routed.*

# 4 1/4" Square Box Newels 4630 / 4631 Models



4630/4631  
BOX NEWEL COLLECTION

★★★ MADE IN THE USA ★★★

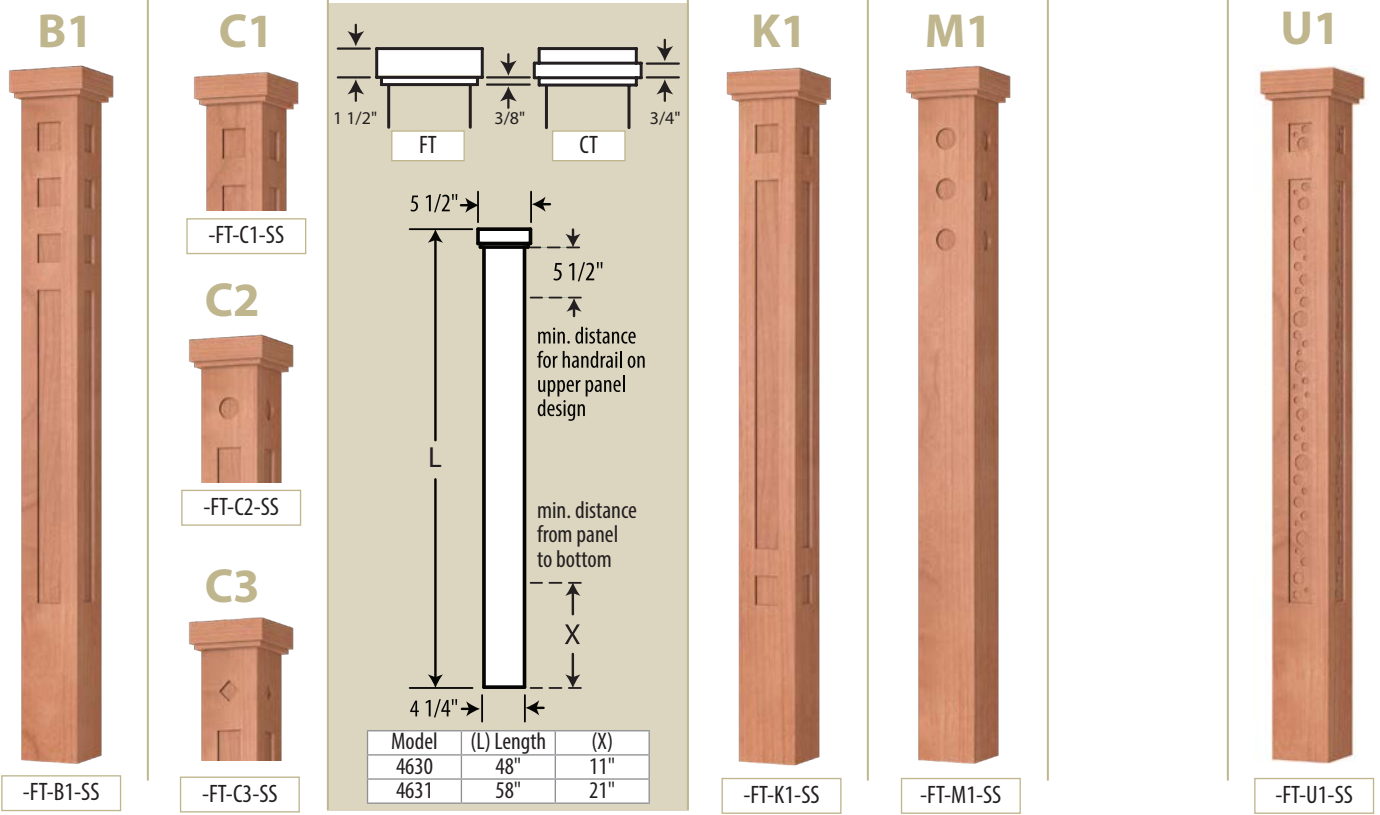
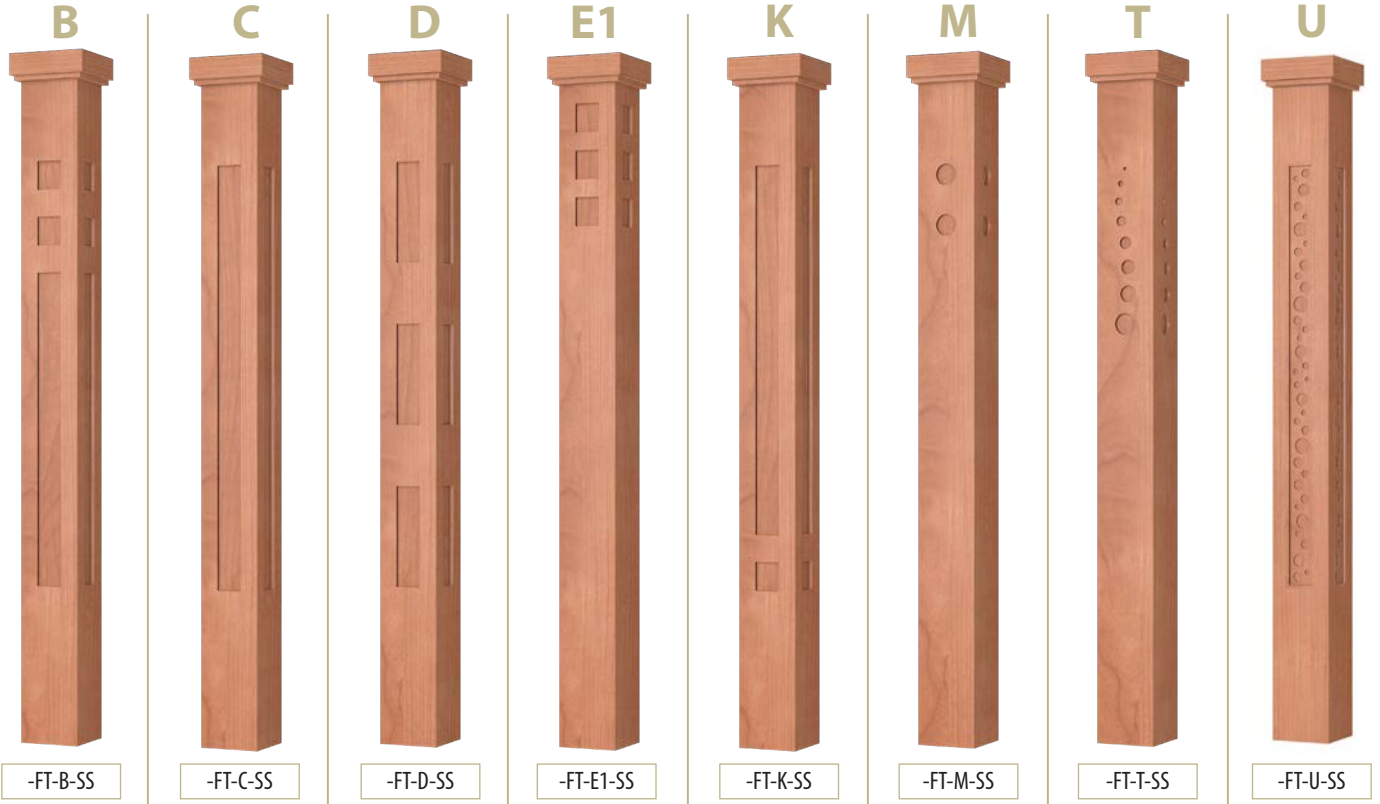

**Order information:** Model Number | Cap Type | Sticking | Species | Panel Species  
 EXAMPLE >>> | 4630 | FT | SP | SMPL | Stainless Steel

Side 1 Side 2 Side 3 Side 4  
 C2 C C C C  
 Side 2 Top View Side 4 Side 1



\*\*\* MADE IN THE USA \*\*\*



A

-FT-A-SS



B

-FT-B-SS



C

-FT-C-SS



D

-FT-D-SS



E2

-FT-E2-SS



F

-FT-F-SS



J

-FT-J-SS



A1

-FT-A1-SS



B1

-FT-B1-SS



C1

-FT-C1-SS



C2

-FT-C2-SS



C3

-FT-C3-SS

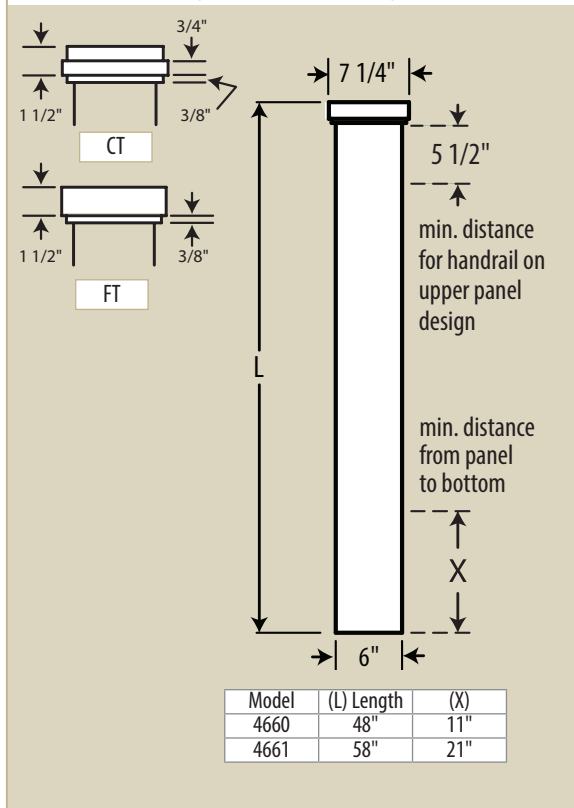

J1



-FT-J1-SS

Order information:

EXAMPLE >>>

Model Number

4660

Cap Type

FT

Sticking

SS

Species

SMPL

Panel Species

SMPL

Side 1

A1

Side 2

Plain

Side 3

A1

Side 4

Plain

Side 2  
Top View  
Side 1



# 6" Square Box Newels 4660 / 4661 Models

(continued)



4660/4661  
BOX NEWEL COLLECTION

★★★ MADE IN THE USA ★★★



-FT-K-SS

-FT-M-SS

-FT-T-SS

-FT-U-SS



-FT-K1-SS

-FT-M1-SS

-FT-U1-SS

## Sticking

### Square Sticking and Step Sticking Information



Square Sticking (SS)

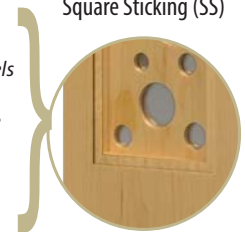

Step Sticking (SP)  
1/4" x 1/4"

*NOTE: Designs U or U1 with stainless steel panels must use step sticking. The wood portion of the U or U1 panels and step sticking will ship loose for field assembly after finishing.*

## Wood Species or Stainless Steel Examples



Matching Wood Species

Different Wood Species

Stainless Steel 304 Satin #4 Finish

## Side Selection Examples



Matching Sides

One Side Only

Different Side Designs



## 4092T, 4293T, 4294T Series

### 4092T Square Tapered Series

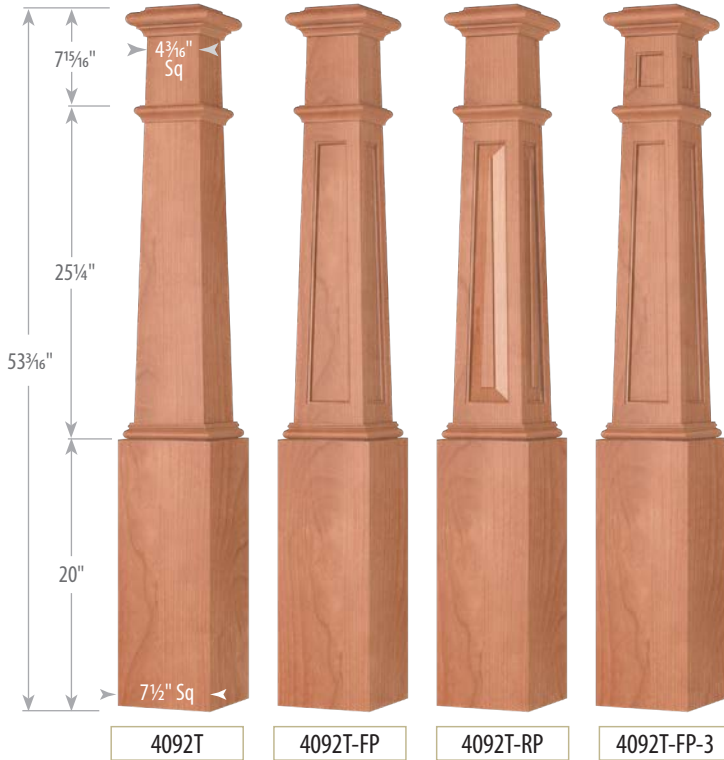

FP = Flat Panel, RP = Raised Panel (NOTE: Top Panel - FP only)

### 4294T Square Tapered Series



FP = Flat Panel, RP = Raised Panel

### 4092T Octagon Tapered

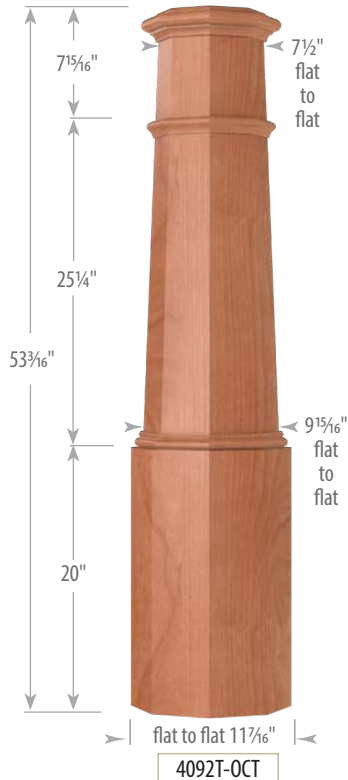

### 4293T Square Tapered Series

**Long Panel Option**  
NOTE: Standard on front side only



FP = Flat Panel, RP = Raised Panel

# 3 1/2" Square Box Newels 4075 Series



**4075**  
BOX NEWEL COLLECTION

★★★ MADE IN THE USA ★★★

FULL SOLID CORE  
OPTION AVAILABLE  
BY REQUEST FOR ALL  
4075 MODELS



Designate by adding  
"-SC" to any model

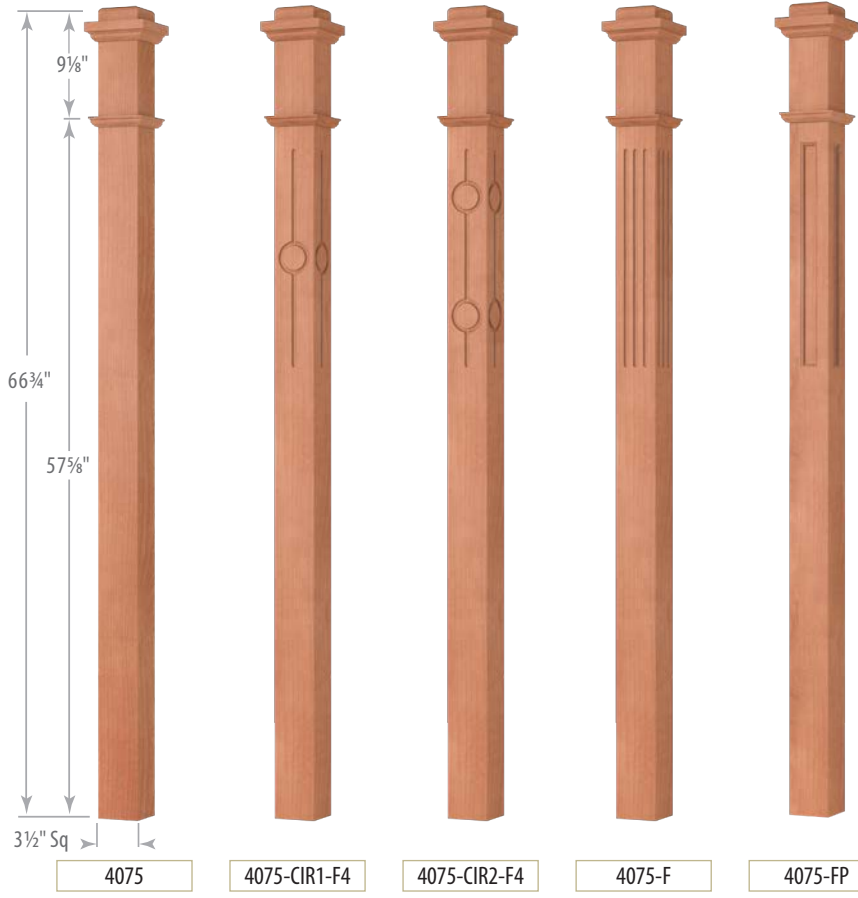

4075      4075-CIR1-F4      4075-CIR2-F4      4075-F      4075-FP



4075-FP-2E      4075-M4L-VG4      4075-M4R-VG4      4075-M6C-VG4      4075-M9-VG4

**Sleeve option**

Mouldings  
shipped  
loose and  
unmitered

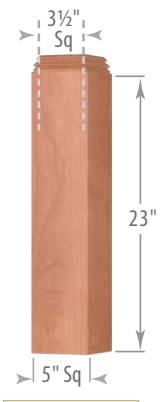

4075-SL



4075-F shown with 4075-SL



# 6 1/4" Square Box Newels 4091 Models

\*\*\* MADE IN THE USA \*\*\*

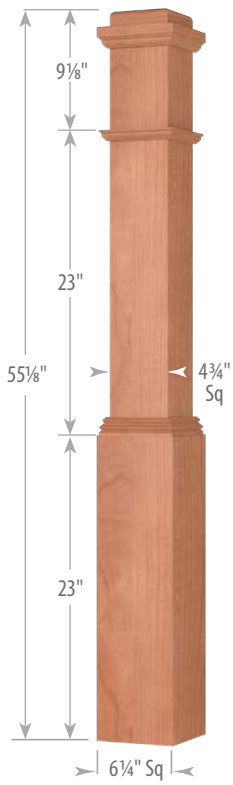

4091



4091-CIR1-F4



4091-CIR2-F4



4091-F



4091-M4L-VG4



4091-M4R-VG4



4091-M6C-VG4

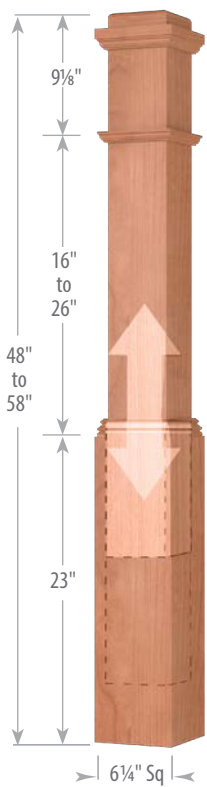

Adjustable from 48" to 58"

4091-ADJ  
Plain only



4091-FP-2E



4091-FP-2E-ET



4091-FP-2E-RT



4091-RP



4091-RP-ET



4091-RP-RT



# 6 1/4" Square Box Newels / 4091 Models (continued)



4091-M9-VG4



4091-FP



4091-FP-ET



4091-FP-RT



4091-RP-2E



4091-RP-2E-ET



4091-RP-2E-RT

| Milling & Panel Options          | Code     |
|----------------------------------|----------|
| Circle 1 Fluted                  | CIR1-F4  |
| Circle 2 Fluted                  | CIR2-F4  |
| Fluted                           | F        |
| <b>Mission</b>                   |          |
| LH V-Grooved                     | M4L-VG4  |
| RH V-Grooved                     | M4R-VG4  |
| 6 Centered V-Grooved             | M6C-VG4  |
| 9 V-Grooved                      | M9-VG4   |
| <b>Flat Panel</b>                |          |
| Flat Panel                       | FP       |
| Eyebrow Top                      | FP-ET    |
| Round Top                        | FP-RT    |
| 2 Even Flat Panels               | FP-2E    |
| 2 Even Flat Panels Eyebrow Top   | FP-2E-ET |
| 2 Even Flat Panels Round Top     | FP-2E-RT |
| <b>Raised Panel</b>              |          |
| Raised Panel                     | RP       |
| Eyebrow Top                      | RP-ET    |
| Round Top                        | RP-RT    |
| 2 Even Raised Panels             | RP-2E    |
| 2 Even Raised Panels Eyebrow Top | RP-2E-ET |
| 2 Even Raised Panels Round Top   | RP-2E-RT |

## Extended Base

Extended Bases for 4091, 4092 and 4291 series Box Newels are available for side mounting or landing applications. Please specify your requirements.



4091 shown with overall height of 72" and base of 40".



# 7½" Square Box Newels 4292 Models

\*\*\* MADE IN THE USA \*\*\*

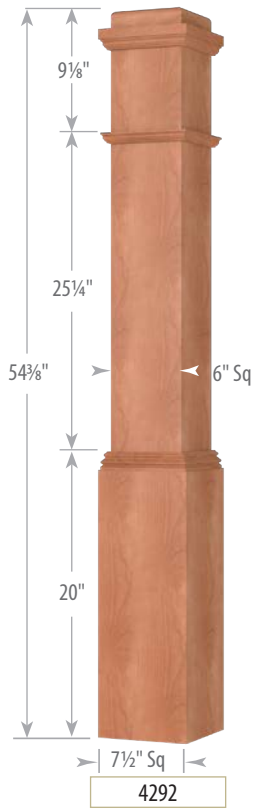

4292-CIR1-F4



4292-CIR2-F4



4292-F



4292-M4L-VG4



4292-M4R-VG4



4292-FP-RT



4292-FP-2E



4292-FP-2E-ET



4292-FP-2E-RT



4292-RP



4292-RP-ET

# 7 1/2" Square Box Newels 4292 Models (continued)



4292-M6C-VG4



4292-M9-VG4



4292-FP



4292-FP-ET



4292-RP-RT



4292-RP-2E



4292-RP-2E-ET



4292-RP-2E-RT

| Milling & Panel Options          | Code     |
|----------------------------------|----------|
| Circle 1 Fluted                  | CIR1-F4  |
| Circle 2 Fluted                  | CIR2-F4  |
| Fluted                           | F        |
| <b>Mission</b>                   |          |
| LH V-Grooved                     | M4L-VG4  |
| RH V-Grooved                     | M4R-VG4  |
| 6 Centered V-Grooved             | M6C-VG4  |
| 9 V-Grooved                      | M9-VG4   |
| <b>Flat Panel</b>                |          |
| Flat Panel                       | FP       |
| Eyebrow Top                      | FP-ET    |
| Round Top                        | FP-RT    |
| 2 Even Flat Panels               | FP-2E    |
| 2 Even Flat Panels Eyebrow Top   | FP-2E-ET |
| 2 Even Flat Panels Round Top     | FP-2E-RT |
| <b>Raised Panel</b>              |          |
| Raised Panel                     | RP       |
| Eyebrow Top                      | RP-ET    |
| Round Top                        | RP-RT    |
| 2 Even Raised Panels             | RP-2E    |
| 2 Even Raised Panels Eyebrow Top | RP-2E-ET |
| 2 Even Raised Panels Round Top   | RP-2E-RT |



# Box Columns

- Available for all box newel series
- Available plain
- Available with milling options- see page 55
- Available with panel options - see pages 56-57
- Caps optional
- Upper shaft mouldings shipped loose and not mitered
- Contact us with your specifications and request a quotation

4092BC

Shown with Cap

4091BC

96" Height

108" Height



6 1/4" Sq

4091BC-96-FP-2E

7 1/2" Sq

4092BC-108-M4L-VG4



# 3 1/2" Square Box Newels 4076 Models



**4076**  
BOX NEWEL COLLECTION

★★★ MADE IN THE USA ★★★

FULL SOLID CORE  
OPTION AVAILABLE  
BY REQUEST FOR ALL  
4075 MODELS



Designate by adding  
"-SC" to any model

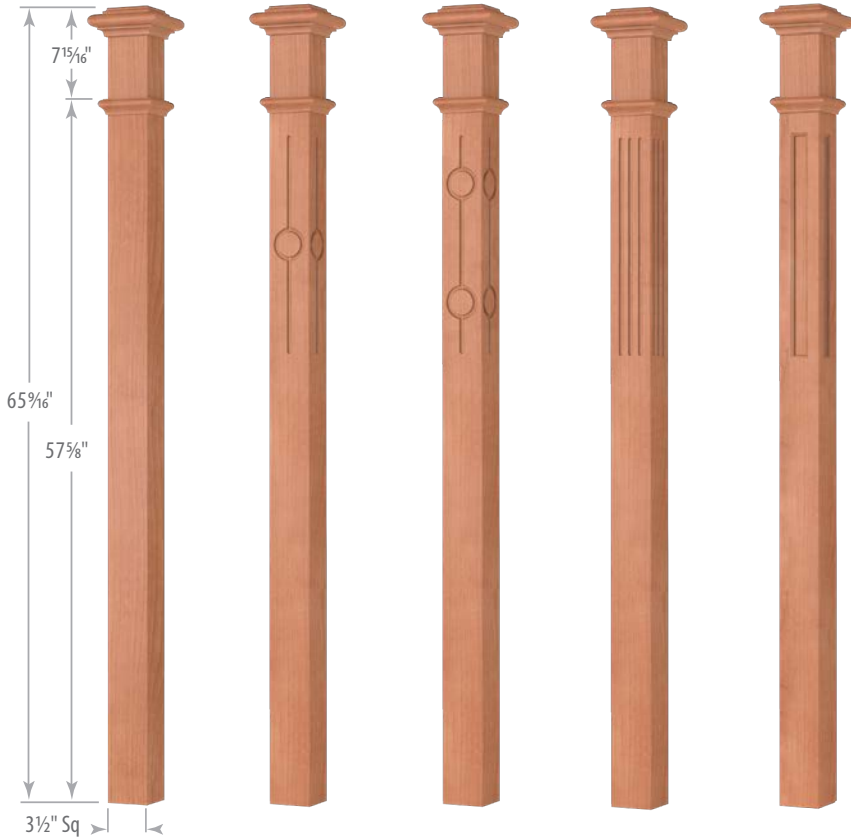

4076

4076-CIR1-F4

4076-CIR2-F4

4076-F

4076-FP



4076-FP-2E

4076-M4L-VG4

4076-M4R-VG4

4076-M6C-VG4

4076-M9-VG4

**Sleeve  
option**

Mouldings  
shipped  
loose and  
unmitered

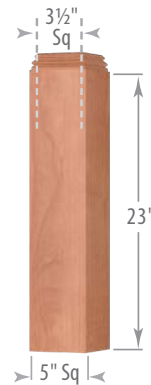

4075-SL



4076 shown with 4075-SL



# 6 1/4" Square Box Newels 4291 Models

\*\*\* MADE IN THE USA \*\*\*

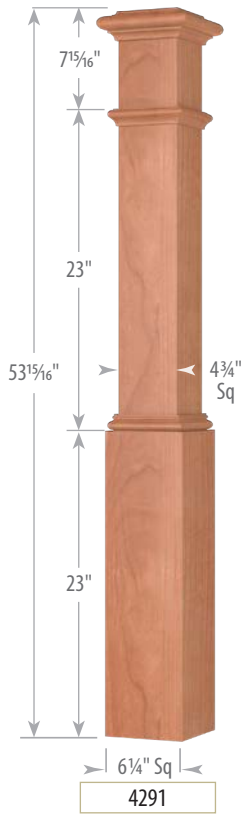

4291-CIR1-F4



4291-CIR2-F4



4291-F



4291-M4L-VG4



4291-M4R-VG4



4291-M6C-VG4



4291-FP-2E



4291-FP-2E-ET



4291-FP-2E-RT



4291-RP



4291-RP-ET



4291-RP-RT



4291-RP-2E

# 6 1/4" Square Box Newels 4291 Models (continued)



4291-M9-VG4



4291-FP



4291-FP-ET



4291-FP-RT



4291-RP-2E-ET



4291-RP-2E-RT



4291-FP-DTB

| Milling & Panel Options                         | Code     |
|---|----------|
| Circle 1 Fluted                                 | CIR1-F4  |
| Circle 2 Fluted                                 | CIR2-F4  |
| Fluted  | F        |
| <b>Mission</b>                                  |          |
| LH V-Grooved                                    | M4L-VG4  |
| RH V-Grooved                                    | M4R-VG4  |
| 6 Centered V-Grooved                            | M6C-VG4  |
| 9 V-Grooved                                     | M9-VG4   |
| <b>Flat Panel</b>                               |          |
| Flat Panel                                      | FP       |
| Eyebrow Top                                     | FP-ET    |
| Round Top                                       | FP-RT    |
| 2 Even Flat Panels                              | FP-2E    |
| 2 Even Flat Panels Eyebrow Top                  | FP-2E-ET |
| 2 Even Flat Panels Round Top                    | FP-2E-RT |
| <b>Raised Panel</b>                             |          |
| Raised Panel                                    | RP       |
| Eyebrow Top                                     | RP-ET    |
| Round Top                                       | RP-RT    |
| 2 Even Raised Panels                            | RP-2E    |
| 2 Even Raised Panels Eyebrow Top                | RP-2E-ET |
| 2 Even Raised Panels Round Top                  | RP-2E-RT |
| <b>Routed Panel</b>                             |          |
| Diamond/Trapezoid Flat Panels, Beveled Sticking | FP-DTB   |

8078 Base Moulding



4291 shown with 8078 Base Moulding option. Also available on 4092.



# 7 1/2" Square Box Newels 4092 Models

\*\*\* MADE IN THE USA \*\*\*





# 7½" Square Box Newels 4092 Models (continued)



4092-M9-VG4

4092-FP

4092-FP-ET

4092-FP-RT



4092-RP-2E-ET

4092-RP-2E-RT

4092-FP-FL

4092-FP-DTB



## Large Sticking

4092-FP-LS

shown with Flat Panel and Large Sticking

NOTE: Large Sticking only available on 4092 and 4292 Series and only on Flat Panel option

| Milling & Panel Options                         | Code     |
|---|----------|
| Circle 1 Fluted                                 | CIR1-F4  |
| Circle 2 Fluted                                 | CIR2-F4  |
| Fluted  | F        |
| <b>Mission</b>                                  |          |
| LH V-Grooved                                    | M4L-VG4  |
| RH V-Grooved                                    | M4R-VG4  |
| 6 Centered V-Grooved                            | M6C-VG4  |
| 9 V-Grooved                                     | M9-VG4   |
| <b>Flat Panel</b>                               |          |
| Flat Panel                                      | FP       |
| Eyebrow Top                                     | FP-ET    |
| Round Top                                       | FP-RT    |
| 2 Even Flat Panels                              | FP-2E    |
| 2 Even Flat Panels Eyebrow Top                  | FP-2E-ET |
| 2 Even Flat Panels Round Top                    | FP-2E-RT |
| Flat Panel with Flowers                         | FP-FL    |
| <b>Raised Panel</b>                             |          |
| Raised Panel                                    | RP       |
| Eyebrow Top                                     | RP-ET    |
| Round Top                                       | RP-RT    |
| 2 Even Raised Panels                            | RP-2E    |
| 2 Even Raised Panels Eyebrow Top                | RP-2E-ET |
| 2 Even Raised Panels Round Top                  | RP-2E-RT |
| <b>Routed Panel</b>                             |          |
| Diamond/Trapezoid Flat Panels, Beveled Sticking | FP-DTB   |



## 4 1/4" Square Box Newels 4392 Models

\*\*\* MADE IN THE USA \*\*\*

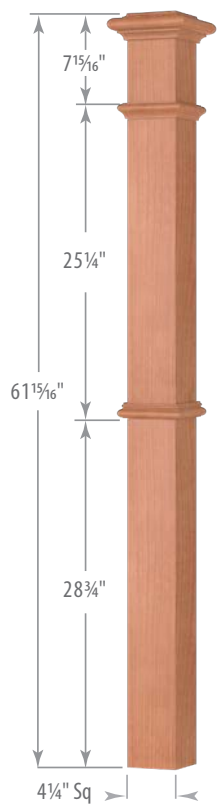

4392

4392-CIR1-F4

4392-CIR2-F4

4392-F

4392-M4L-VG4

4392-M4R-VG4

4392-M6C-VG4



4392-FP-2E-ET



4392-FP-2E-RT



4392-RP



4392-RP-ET



4392-RP-RT



4392-RP-2E



4392-RP-2E-ET

# 4 1/4" Square Box Newels 4392 Models (continued)



**4392**  
BOX NEWEL COLLECTION

★★★ MADE IN THE USA ★★★



4392-M9-VG4



4392-FP



4392-FP-ET



4392-FP-RT



4392-FP-2E



4392-RP-2E-RT



4392-FP-DTB

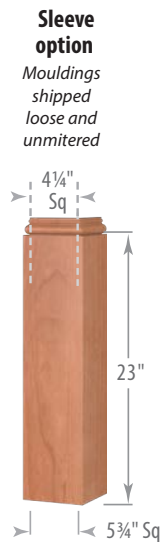

4392-SL

| Milling & Panel Options                         | Code     |
|---|----------|
| Circle 1 Fluted                                 | CIR1-F4  |
| Circle 2 Fluted                                 | CIR2-F4  |
| Fluted  | F        |
| <b>Mission</b>                                  |          |
| LH V-Grooved                                    | M4L-VG4  |
| RH V-Grooved                                    | M4R-VG4  |
| 6 Centered V-Grooved                            | M6C-VG4  |
| 9 V-Grooved                                     | M9-VG4   |
| <b>Flat Panel</b>                               |          |
| Flat Panel                                      | FP       |
| Eyebrow Top                                     | FP-ET    |
| Round Top                                       | FP-RT    |
| 2 Even Flat Panels                              | FP-2E    |
| 2 Even Flat Panels Eyebrow Top                  | FP-2E-ET |
| 2 Even Flat Panels Round Top                    | FP-2E-RT |
| <b>Raised Panel</b>                             |          |
| Raised Panel                                    | RP       |
| Eyebrow Top                                     | RP-ET    |
| Round Top                                       | RP-RT    |
| 2 Even Raised Panels                            | RP-2E    |
| 2 Even Raised Panels Eyebrow Top                | RP-2E-ET |
| 2 Even Raised Panels Round Top                  | RP-2E-RT |
| <b>Routed Panel</b>                             |          |
| Diamond/Trapezoid Flat Panels, Beveled Sticking | FP-DTB   |



Multi-species available for added distinction

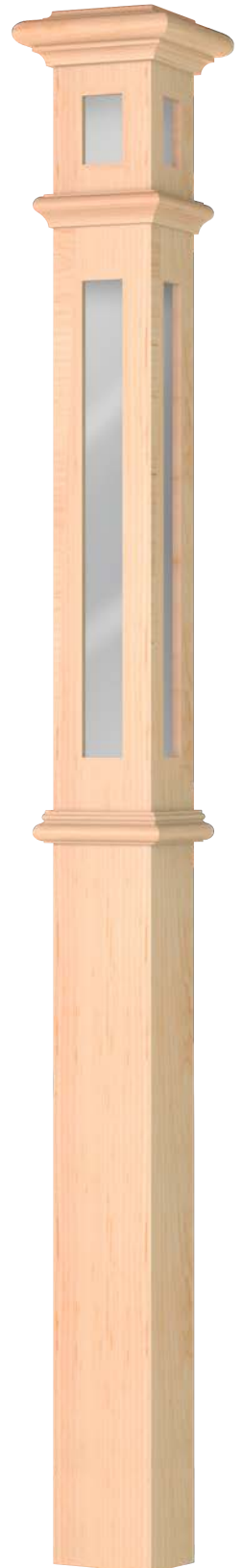

Metal insert example



# OAK POINTE

WHERE TRADITION AND INNOVATION CREATE EXCELLENCE

96 NEW PACE ROAD  
NEWCOMERSTOWN  
OHIO 43832

P 740.498.9820

F 740.498.9821

**GENERAL INQUIRY**

INFO@STAIRPARTSANDMORE.COM

**QUOTE REQUESTS**

QUOTES@STAIRPARTSANDMORE.COM

**SUBMIT ORDERS**

ORDERS@STAIRPARTSANDMORE.COM

Connect with us on:

