



CABINETRY

COMPONENTS • MOULDINGS • BALLS • CORBELS



★★★ *MADE IN THE USA* ★★★

Our **Cabinetry Components & Mouldings Collection** from Oak Pointe, includes finely crafted table pedestals, island columns and legs, bun feet, finials, wood balls, corbels, rope and other mouldings. All components in this collection are for interior use only.

WHERE TRADITION AND INNOVATION CREATE EXCELLENCE

Custom components are an integral part of our business. Call for pricing on your designs for interior and exterior use.

In This Section

Table Pedestals



Base for table top:
Options & Details-
Page 263.

Island Columns & Legs



Both decorative and for support on kitchen island overhangs and tables:
Options & Details-
Pages 264-265.

Bun Feet

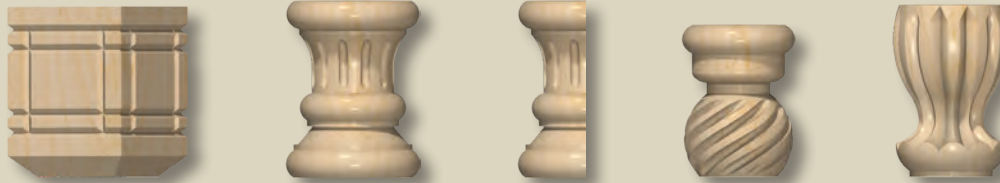

Use Bun Feet to decorate you cabinets or furniture. Options & Details- Pages 274-275.

Finials



Top off any post in style:
Options & Details-
Pages 276-278.

Wood Balls



Choose from diameters up to 1 3/4":
Options & Details-
Page 279.

Mouldings & Boards

Mouldings and S4S Boards for most any application: Options & Details- Page 280.



Corbels

Corbels can be structural or decorative enhancements for interior or exterior. Page 266.



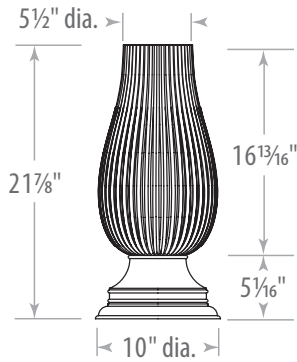

Reeded
Milling
Option

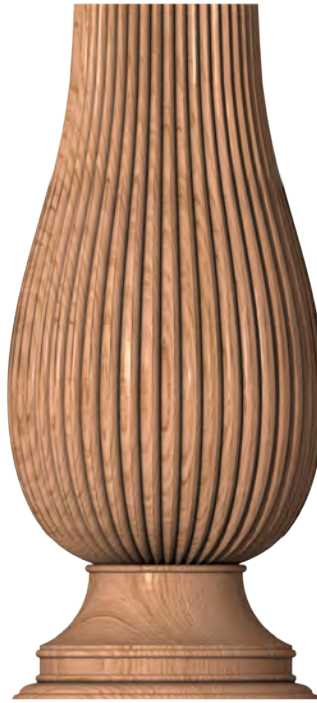

PED-1000-5.5-21.875-R

All table pedestals are per quotation. Sizes shown are just examples and like all of our parts may be changed to suit the needs of each project.

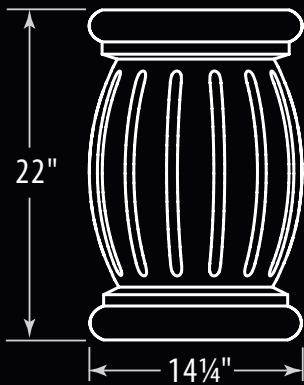

Fluted
Milling
Option









PED-2105-1425-22-F







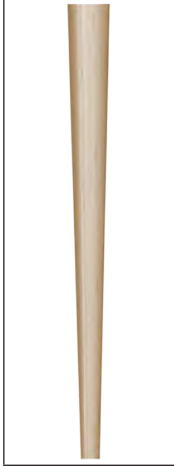









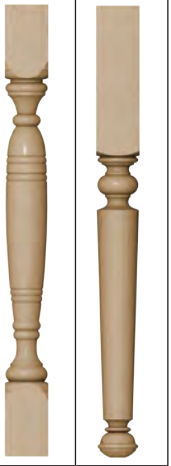

Selection Guide

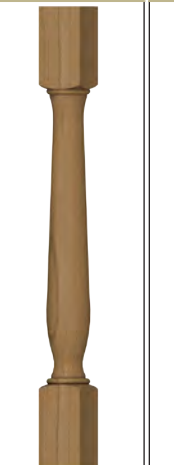
These two pages are an index to every Kitchen Island Leg in this catalog. For available milling options and dimensions, go to the page indicated.

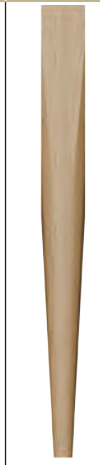

Mt Vernon Columns	Brownstone Columns	Brownstone Legs	Miscellaneous Legs	Round Tapered Legs	Titan Columns
					
see page 267	see page 267	see page 267	see page 268	see page 268	see page 269

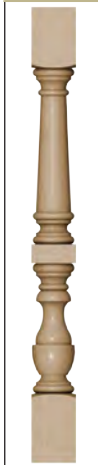
French Manor Legs	Windsor Legs	Wiltshire Columns	Wiltshire Legs	Island Box Columns	Art Deco Columns	Victoria Columns	Victoria Legs
							
see page 270	see page 271	see page 272	see page 272	see page 273	see page 91	see page 97	see page 97

Malta Columns	Main Street Columns	Avenue i Columns	Farm Columns	Farm Legs	Emperor Columns	Federal Columns	Federal Legs	Cambridge Columns	Cambridge Legs
									
see page 78	see page 83	see page 80	see page 86	see page 86	see page 88	see page 102	see page 102	see page 106	see page 106



Selection Guide

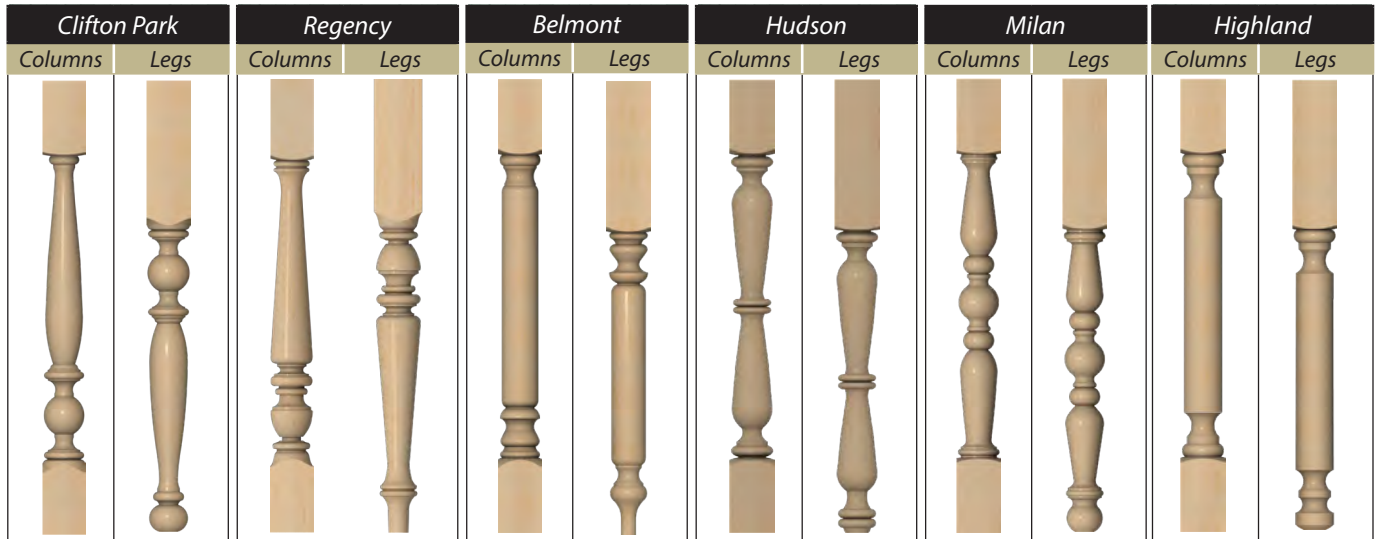

see page 110

see page 114

see page 118

see page 122

see page 126

see page 130

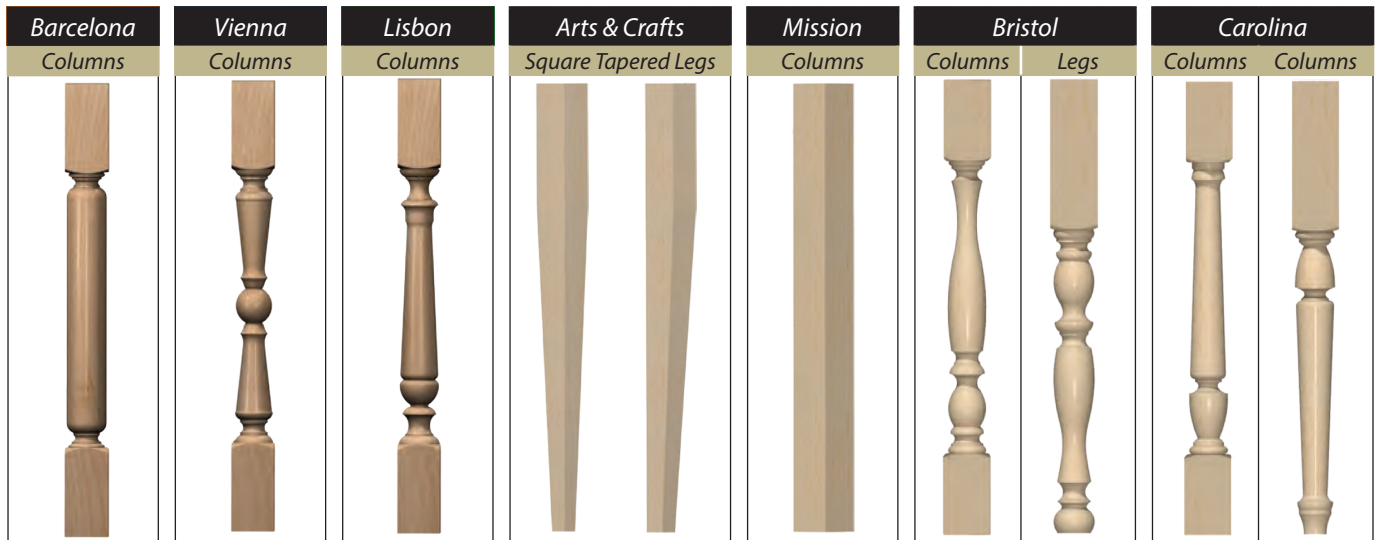

see page 142

see page 146

see page 150

see page 154

see page 160

see page 164

see page 168

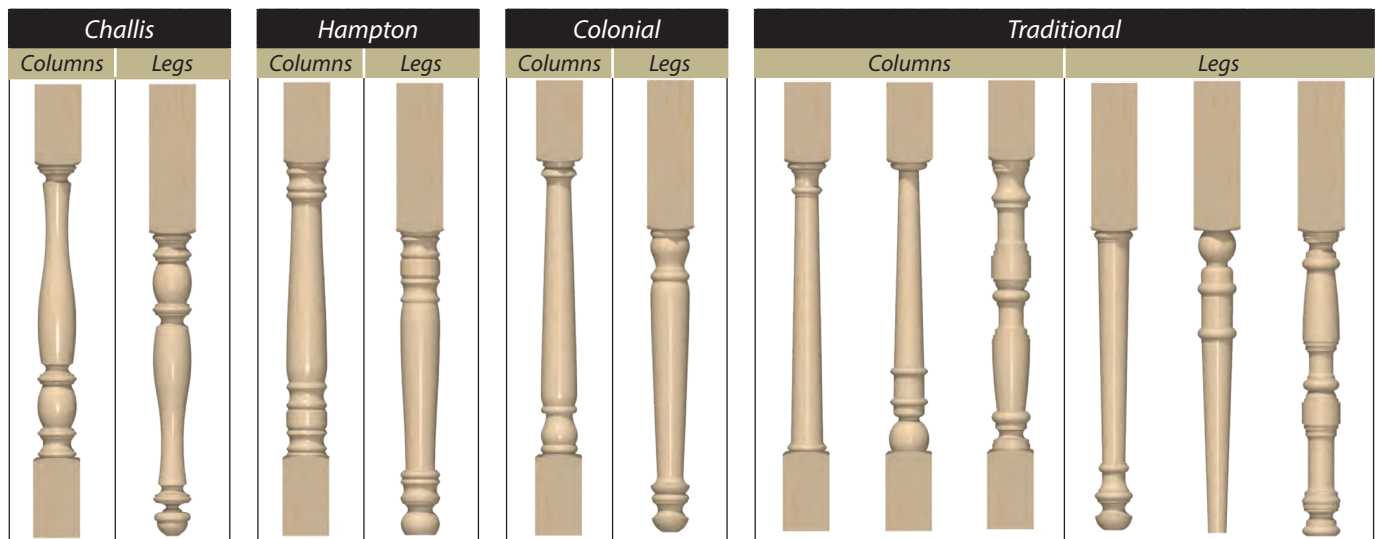

see page 172

see page 178

see page 182

see pages 186-187

Column/Leg Options

Corbels

Corbels can be decorative or structural and have many uses. Interior corbels are used to support kitchen island tops, mantles, range hoods and shelves. On the exterior corbels are used to decorate the eaves of a roof.



Split and Diagonal Split Columns & Legs

must be ordered in pairs. Quarter Columns must be ordered in sets of 4. When ordering half, diagonal half cut and quartered columns the parts will be dimensionally undersized due to the saw cut and sanding. Please note that certain designs are not symmetrical and may not lend themselves to being split.

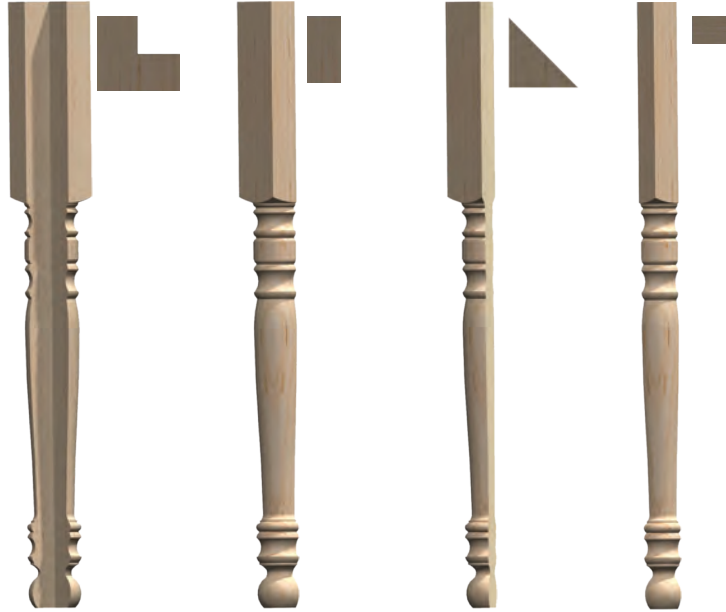

Quarter Notched Split Diagonal Split Quartered

Hampton Series examples - see page 178 in our catalog Edition 4.0

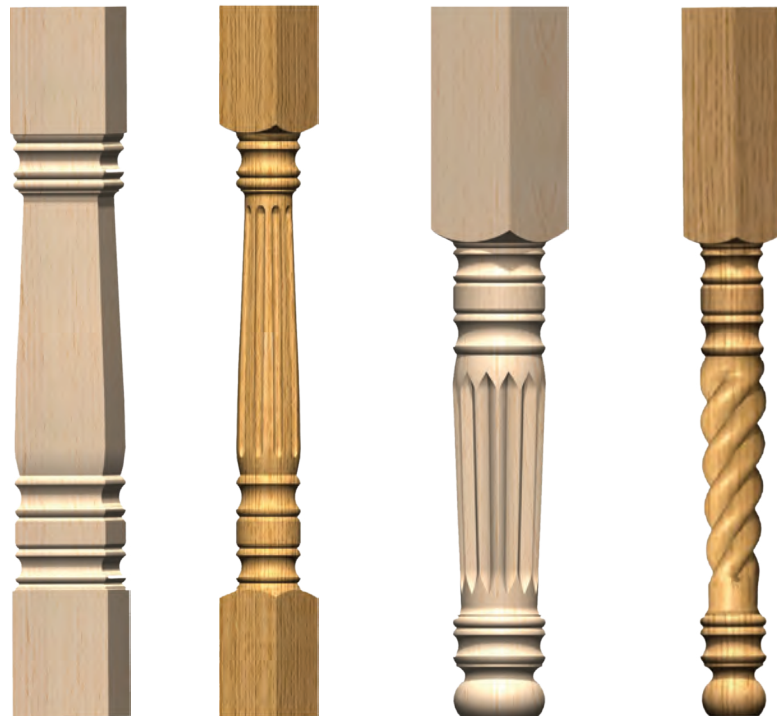

5" Island Column with **Square Milling**

15300-500-SQ

3½" Island Column with **Fluted Milling**

15300-350-F

5" Island Leg with **Reeded Milling**

105300-500-R

3½" Island Leg with **Rope Twist**

105300-350-RTRH

The following pages represent our unique Island Columns, Interior Posts & Legs. They are not associated with specific stair part groups. To see group related Island Columns & Legs, use our convenient Island Columns & Legs Selection Guide on pages 264-265 in our catalog Edition 4.0 for a quick reference guide to each stair part series.

Island Columns

Mt Vernon Series

The Mt Vernon Island Column design was inspired by the father of our country's masterful skill in the neoclassical Georgian architectural style.

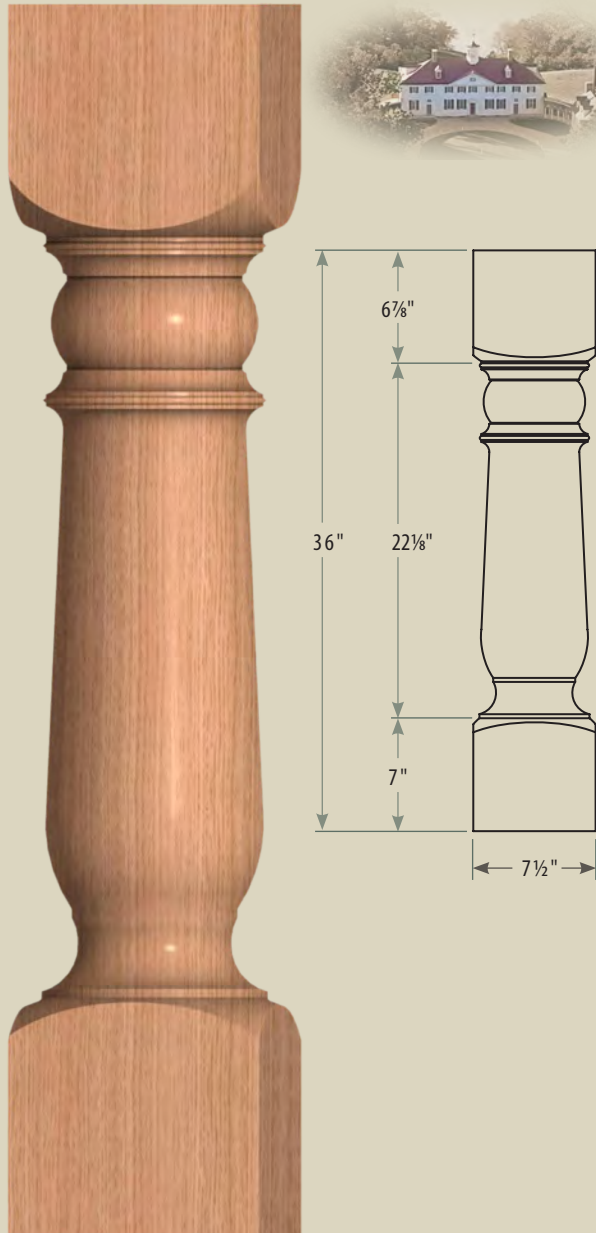

17999-750

Brownstone Series

Square

Round

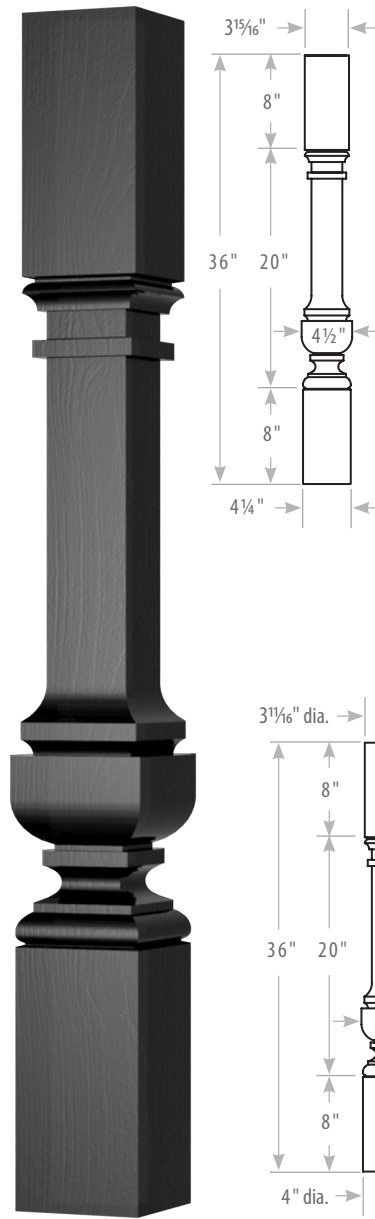

17400-425-SQ

17400-400

Paint grade only.
Custom setup applied to square.



Table Legs

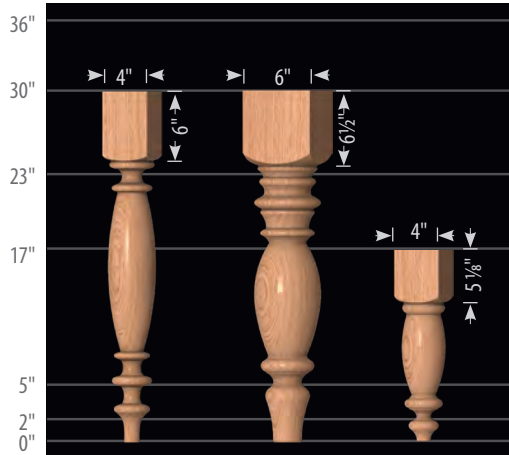

97950-400

Table Leg

97920-600

Table Leg

87910-400

Coffee Table Leg

4" Square Table Leg



97950-400

6" Square Table Leg



97920-600

4" Square Coffee Table Leg



87910-400

Round Tapered Legs

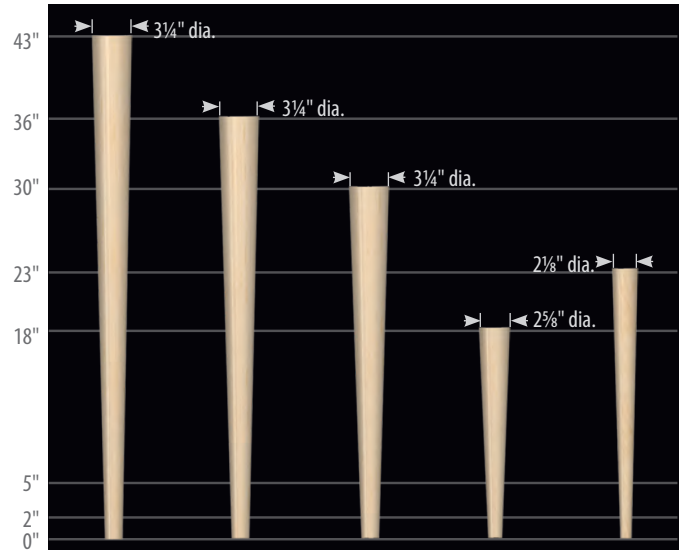

121150-350

Bar Leg

101150-350

Island Leg

91150-350

Table Leg

81150-275

Coffee Table Leg

71150-225

End Table Leg

Round Tapered Milling Options

Milling Options	Corkscrew	Fluted	Fluted 1	Reeded
Code	CS	F	F1	R



-CS



-F



-F1



-R



Titan Island Columns and Legs

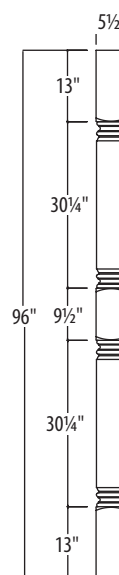
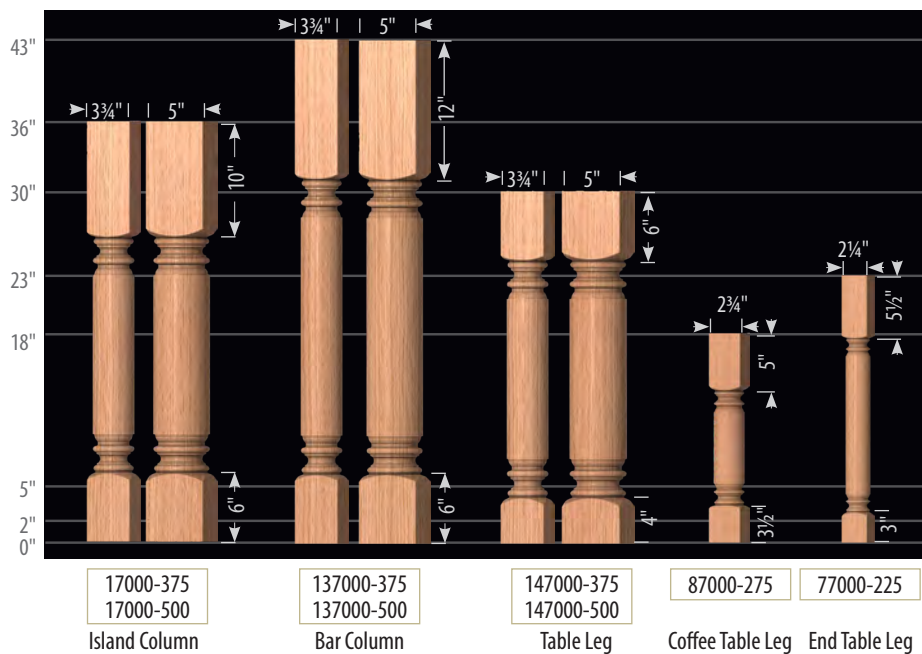

Interior Post
Shown Plain
47000-550

Titan Milling Options

Milling Options	Barley 4	Barley 6 Left Hand	Barley 6 Right Hand	Doric Flute 32	Fluted	Flute with Hip	Reeded	Ribbon 3	Rope Twist Left Hand	Rope Twist Right Hand	Rope Twist 1
Code	BAR4	BAR6LH	BAR6RH	DF32	F	F2	R	RIB3	RTLH	RTRH	RT1

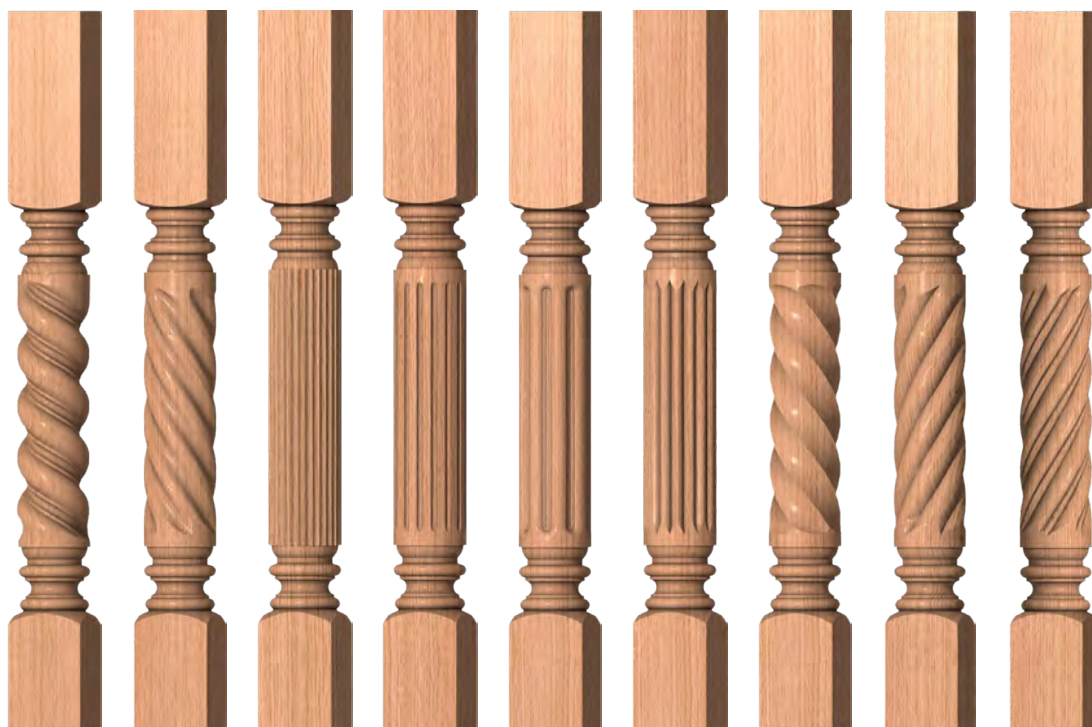

BAR4

BAR6LH*
(LH shown)

DF32

F

F2

R

RIB3

RTRH*
(RH shown)

RT1

* Available in LEFT HAND or RIGHT HAND directions.

Standard post size is 5 1/2" wide and 96" high.

French Manor Island and Table Legs



Interior Post
Shown Plain
47500-550

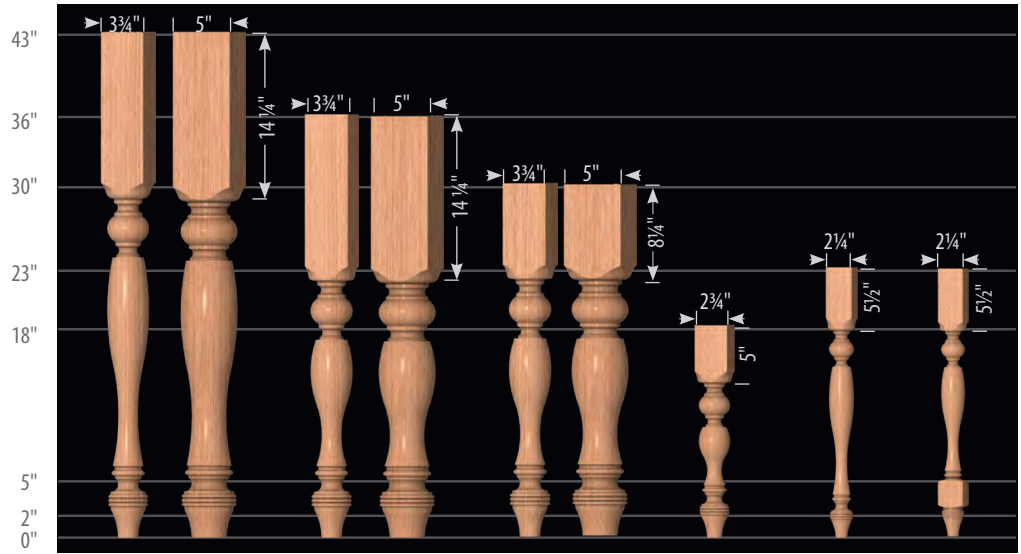
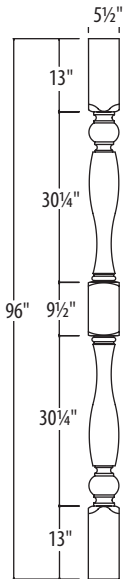

127500-375
127500-500
Bar Leg (Footed)

107500-375
107500-500
Island Leg (Footed)

97500-375
97500-500
Table Leg (Footed)

87500-275
Coffee Table
Leg (Footed)

77500-225
End Table Leg
(Footed)

67500-225
End Table Leg
(w/stretcher block)

French Manor Milling Options

Milling Options	Top Block Milling						
	Corkscrew	Fluted	Reeded	Reeded Ball	Ribbon 2	Fluted Block 1	Fluted Block 2
Code	CS	F	R	RB	RIB2	FB1	FB2

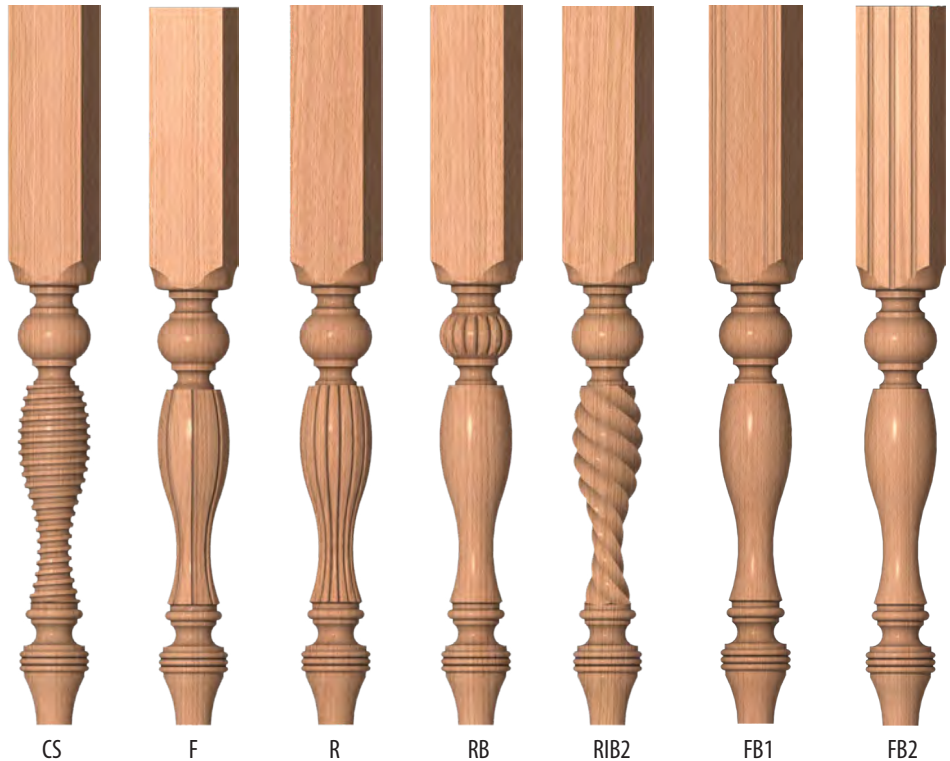

Standard post size is 5 1/2" wide and 96" high.



Windsor Island Columns and Legs

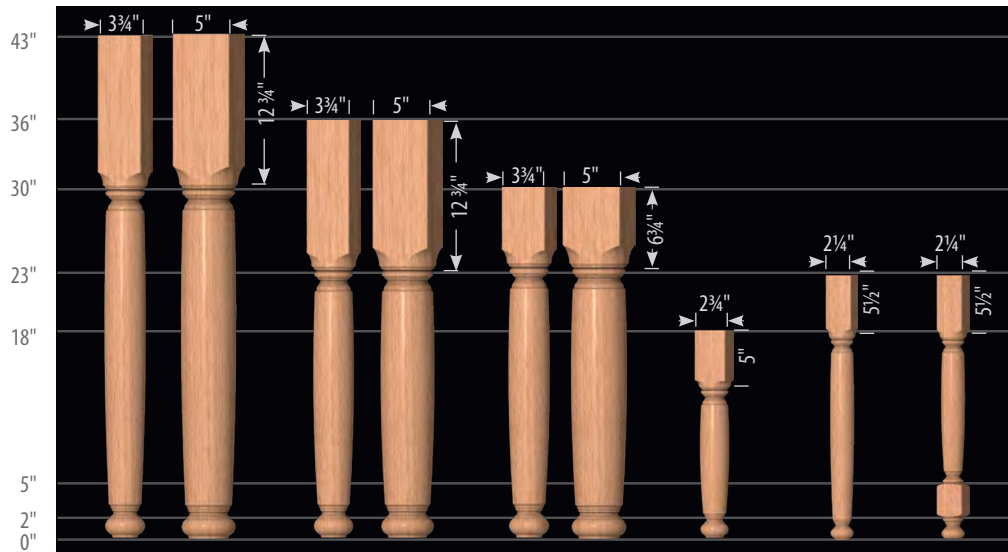

127300-375
127300-500

Bar Leg (Footed)

107300-375
107300-500

Island Leg (Footed)

97300-375
97300-500

Table Leg (Footed)

87300-275

Coffee Table Leg (Footed)

77300-225

End Table Leg (Footed)

67300-225

End Table Leg (w/stretcher block)

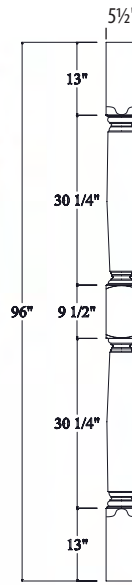

Interior Post
Shown Plain

47300-550

Windsor Milling Options

Milling Options	Barley 6 Left Hand	Barley 6 Right Hand	Corkscrew	Fluted	Octagon	Rope Twist Left Hand	Rope Twist Right Hand	Rope Twist 1	Square	Twisted Flute
Code	BAR6LH	BAR6RH	CS	F	OCT	RTLH	RTRH	RT1	SQ	TF

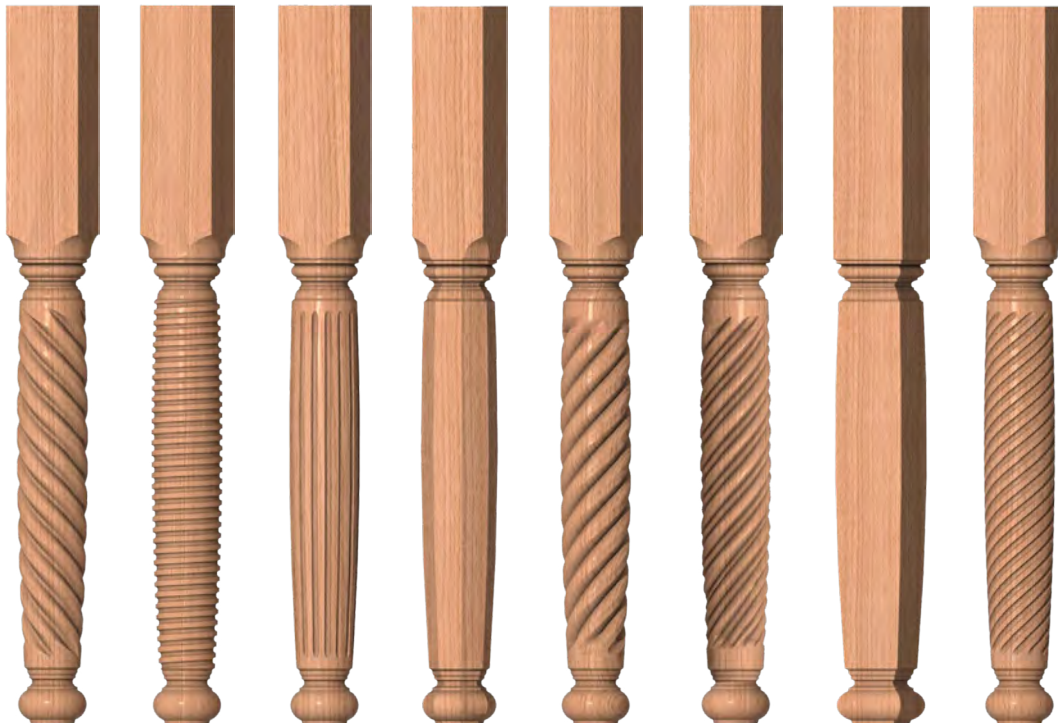

BAR6LH*
(LH shown)

CS

F

OCT^

RTRH*
(RH shown)

RT1

SQ^

TF

* Available in LEFT HAND or RIGHT HAND directions. ^ Island Legs only

Standard post size is 5 1/2" wide and 96" high.



Wiltshire Island and Table Columns

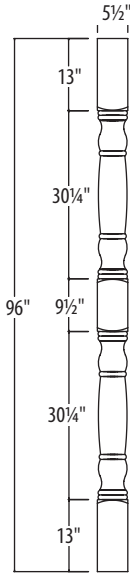

Interior Post
Shown Plain
47550-550

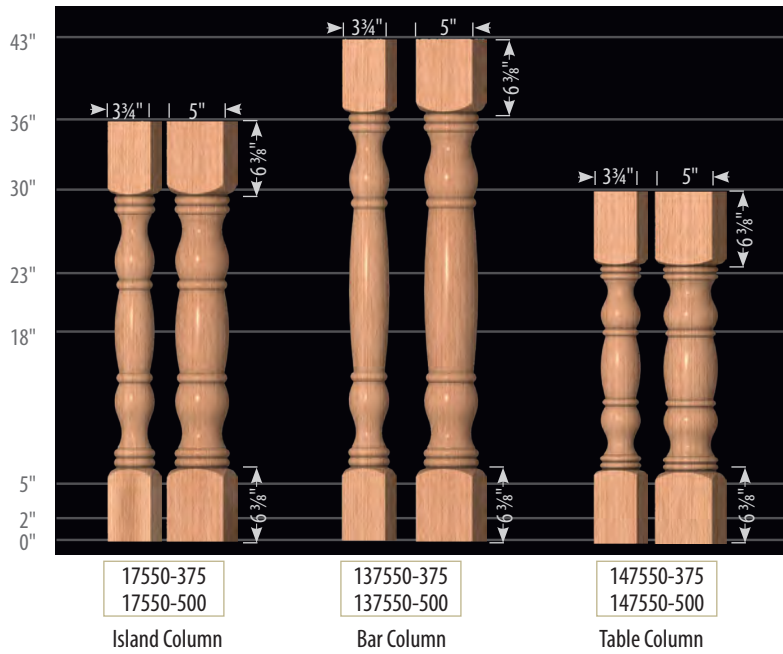

17550-375
Island Column

Wiltshire Island and Table Legs

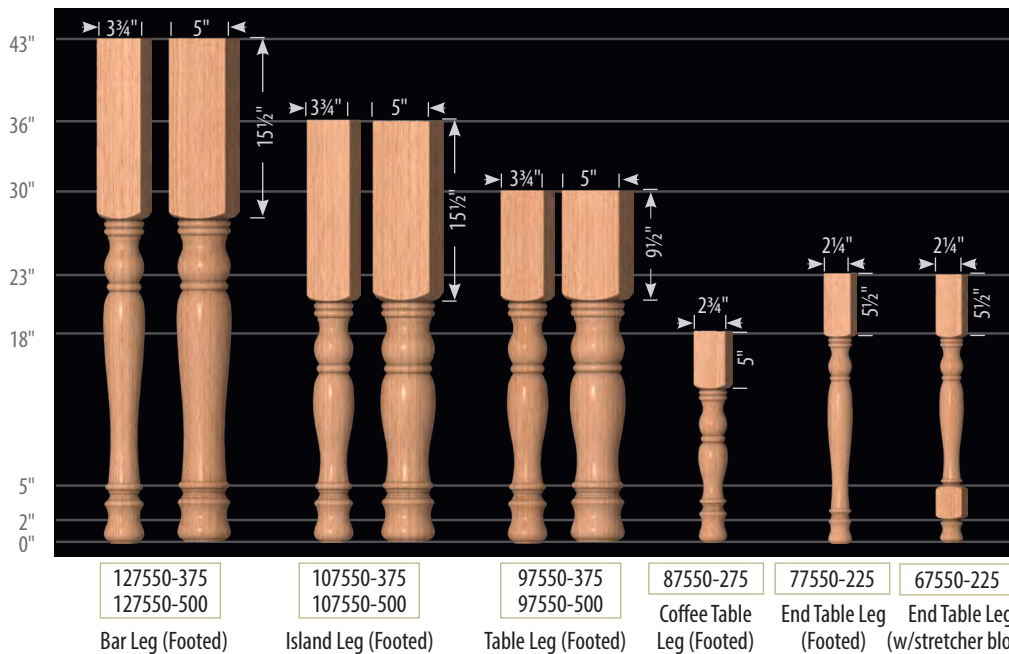

Standard post size is 5 1/2" wide and 96" high.



The Island Box Column may be used with or without the 1 3/4" top cap which is shipped loose for field installation. These columns have face grain on all four sides and have a hollow core. For a weight bearing Island Box Column add "WB" to the part number to get a solid core.

Multi-Species: On any of these styles change the species of the Mouldings and on Panel box columns change the species of the panels. For an authentic Mission look, on Panel configurations, add Square Sticking (add "SS" to the model number) and panels in the upper section! (add -4 to the model number).

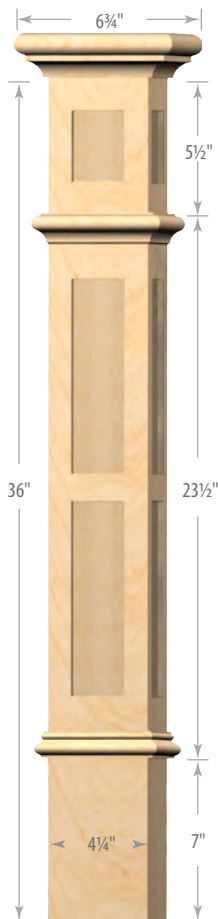

14392-425-FP-2E-SS-4

Milling & Panel Options	Code
Circle 1 Fluted	CIR1-F4
Circle 2 Fluted	CIR2-F4
Fluted	F
Mission	
LH V-Grooved	M4L-VG4
RH V-Grooved	M4R-VG4
6 Centered V-Grooved	M6C-VG4
9 V-Grooved	M9-VG4
Flat Panel	
Flat Panel	FP
Eyebrow Top	FP-ET
Round Top	FP-RT
2 Even Flat Panels	FP-2E
2 Even Flat Panels Eyebrow Top	FP-2E-ET
2 Even Flat Panels Round Top	FP-2E-RT
Raised Panel	
Raised Panel	RP
Eyebrow Top	RP-ET
Round Top	RP-RT
2 Even Raised Panels	RP-2E
2 Even Raised Panels Eyebrow Top	RP-2E-ET
2 Even Raised Panels Round Top	RP-2E-RT

14392-425 Island Box Columns Mission Style Milling Options

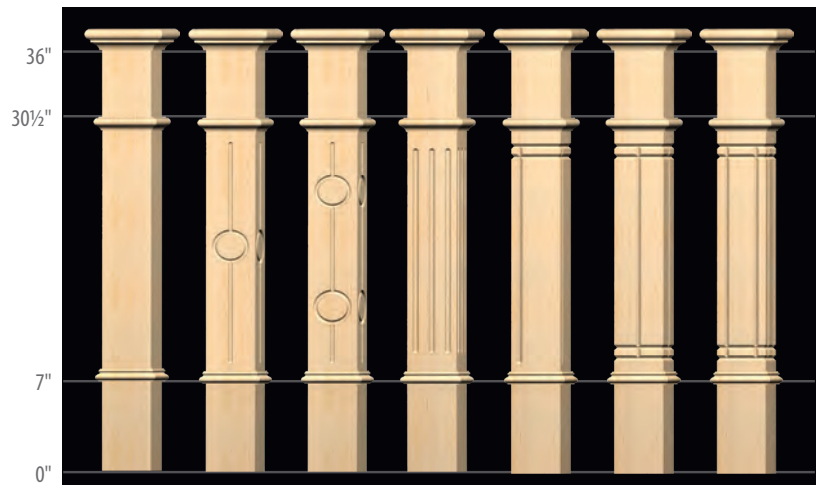

Plain -CIR1-F4 -CIR2-F4 -F -M4L-VG4* -M6C-VG4 -M9-VG4
*for RH version, order 14392-425-M4R-VG4

14392-425 Island Box Columns Flat Panel Options

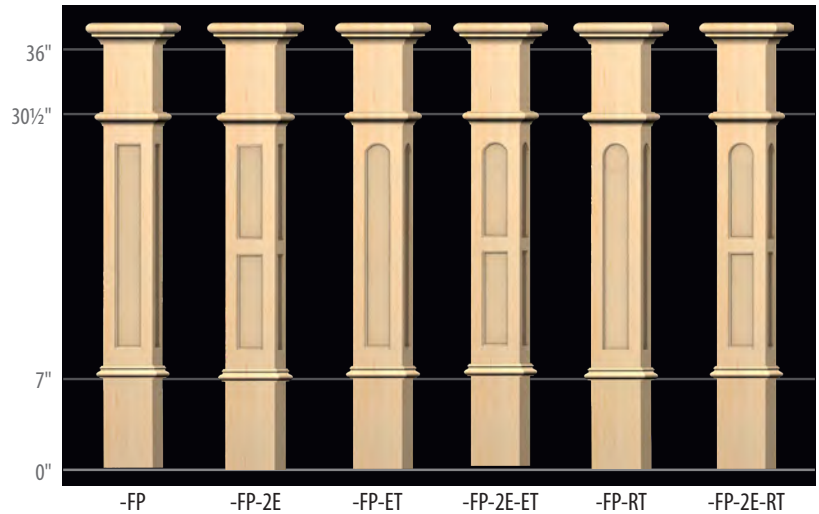

-FP -FP-2E -FP-ET -FP-2E-ET -FP-RT -FP-2E-RT

14392-425 Island Box Columns Raised Panel Options

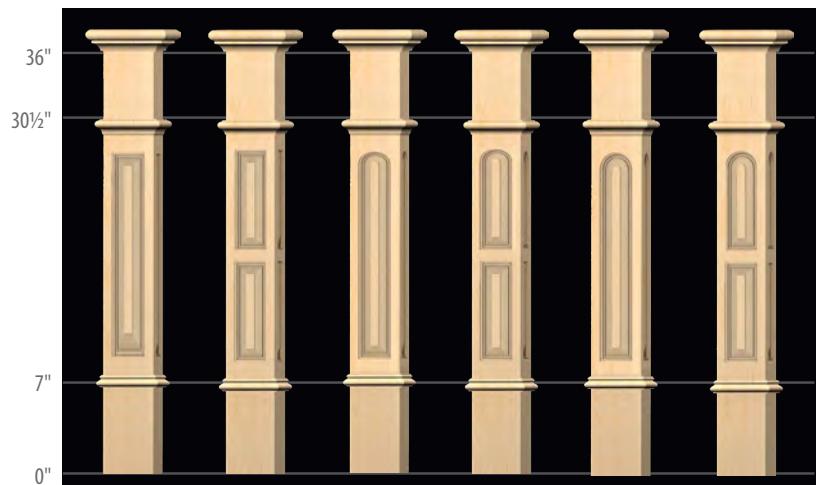

-RP -RP-2E -RP-ET -RP-2E-ET -RP-RT -RP-2E-RT

All of our Island Box Column panels are standard with Round Sticking... order optional Square or Step Sticking*.

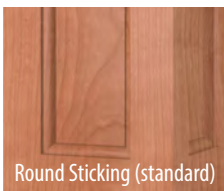

Round Sticking (standard)



Square Sticking (-SS)

See our coordinating Box Newels on pages 74-75 in our catalog Edition 4.0, as well as coordinating Mission legs, columns, bun feet and stair parts.



Step Sticking* (-SP)

*Only available on the FP & RP options.

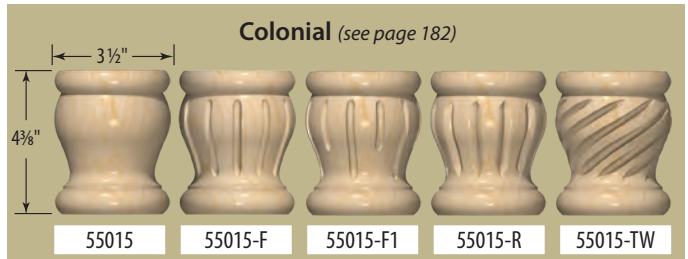
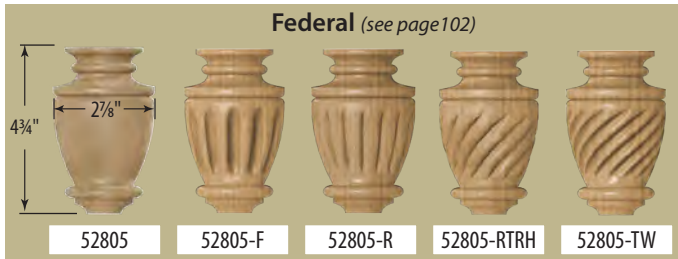
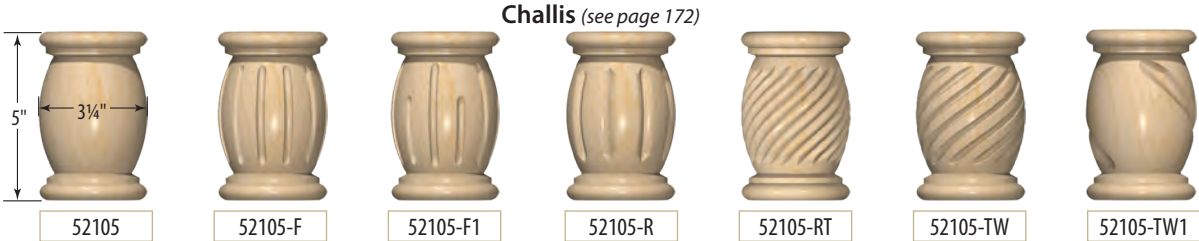
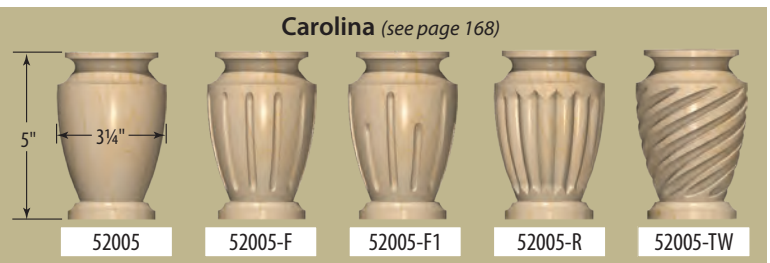
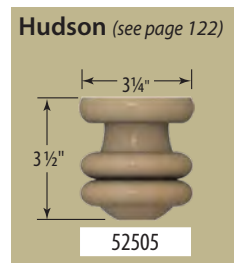
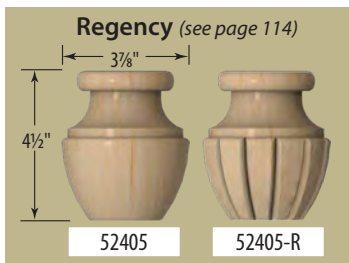
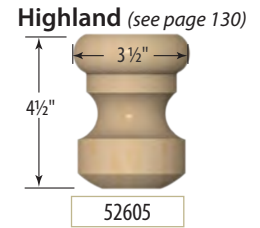
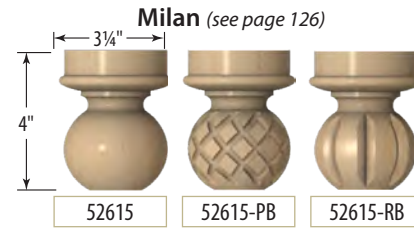
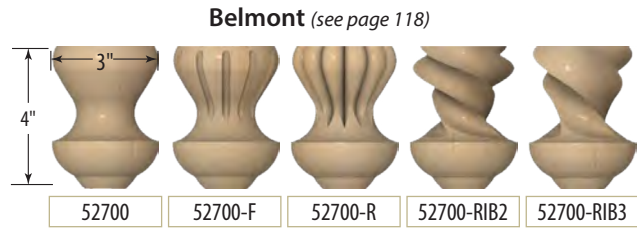
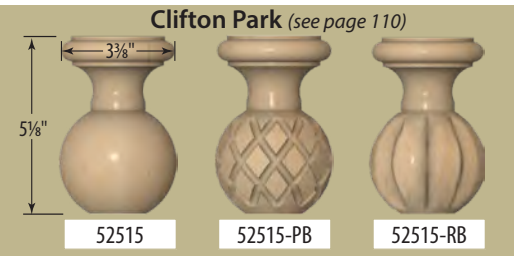
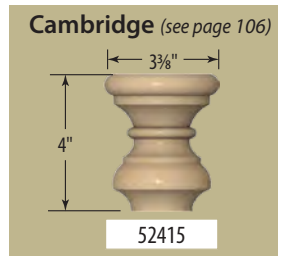
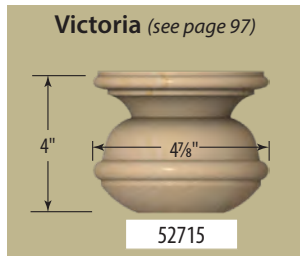
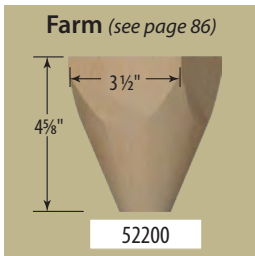
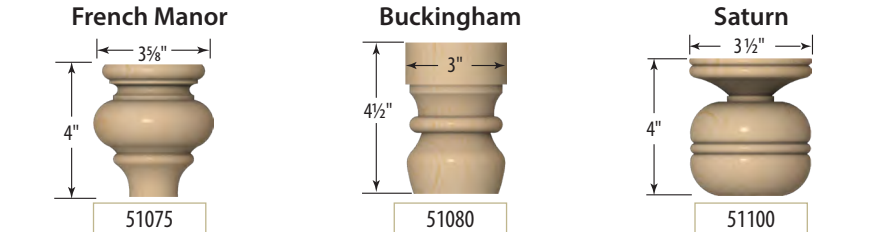
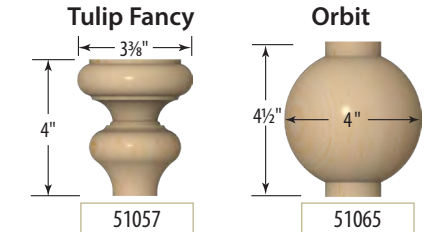
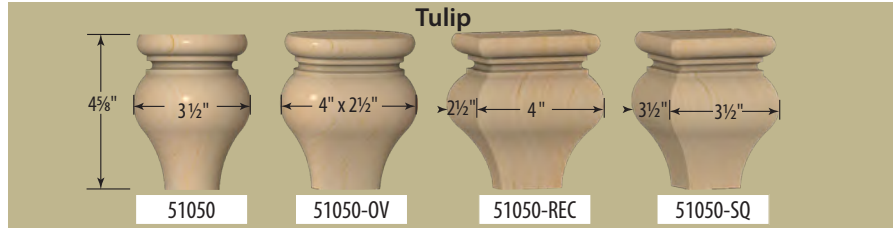
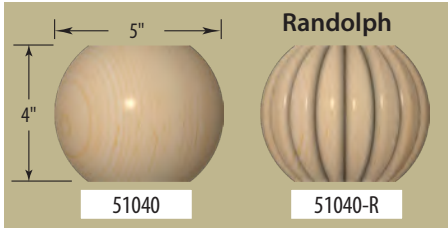

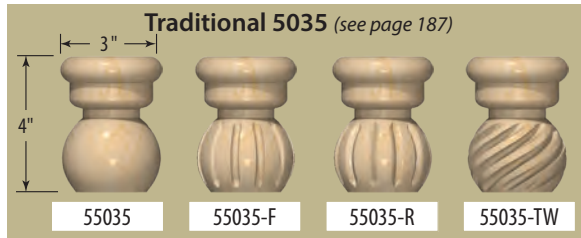
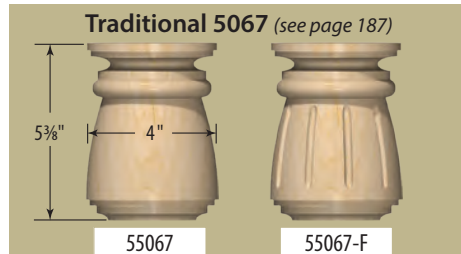
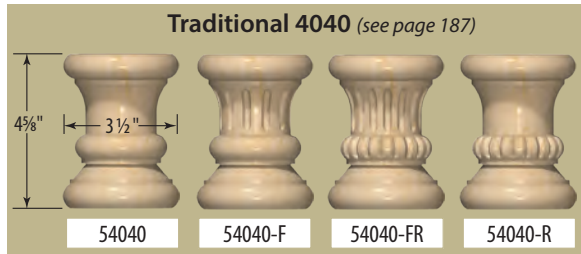

Decorate your cabinetry and furniture with our line of distinguished bun feet.

Available split but must be ordered in pairs. Please note that certain designs are not symmetrical and may not lend themselves to being split.

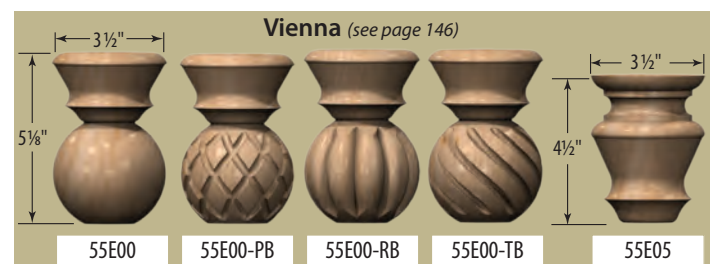
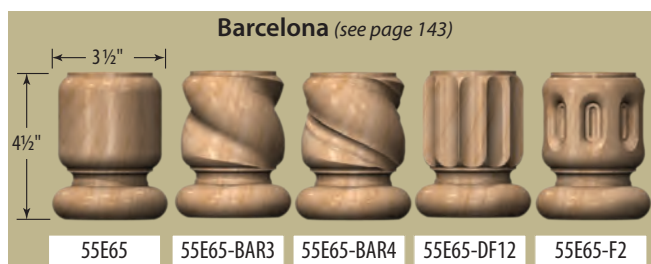
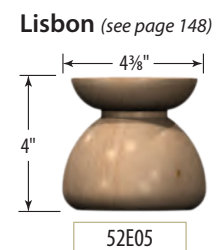
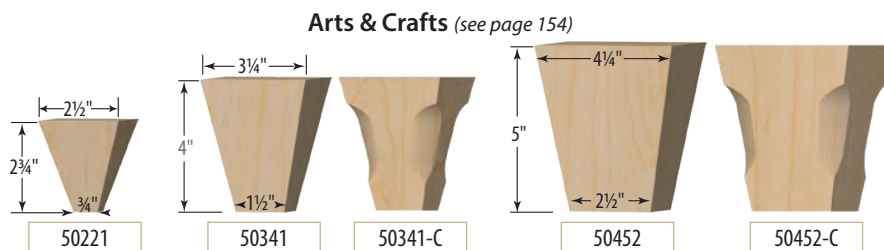
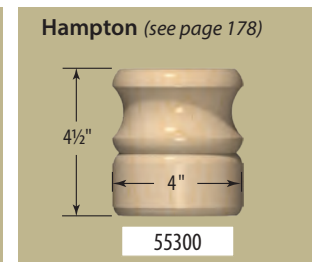
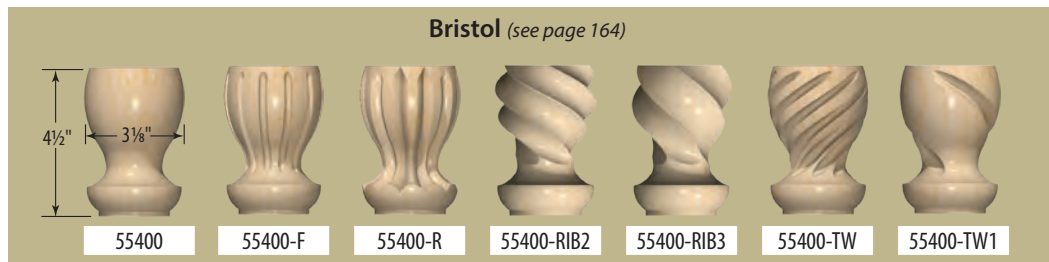



Finials

Choose any of these finials as a post to post newel top, newel drop or applied to box newels as an accent.

Our interior finials are available in all of our hardwood species and others upon request. Exterior finials are available by quotation. **The bottom dowels are 3/4" in diameter on standard sizes.**

The finial model number represents the base diameter, please specify this when ordering.

All finials are available from the smallest of diameters to overall widths of >14"



<p>FINIAL-F20-250 F20 Top</p> <table border="1"> <tr><td>Newel Post Designation</td><td>F20</td></tr> <tr><td>Turned Newel Size*</td><td>3 1/2" min.</td></tr> <tr><td>Shown with Newel</td><td>N/A</td></tr> </table>	Newel Post Designation	F20	Turned Newel Size*	3 1/2" min.	Shown with Newel	N/A	<p>FINIAL-F43-2875 F43 Top</p> <table border="1"> <tr><td>Newel Post Designation</td><td>F43</td></tr> <tr><td>Turned Newel Size*</td><td>5 1/4" min.</td></tr> <tr><td>Shown with Newel</td><td>N/A</td></tr> </table>	Newel Post Designation	F43	Turned Newel Size*	5 1/4" min.	Shown with Newel	N/A	<p>FINIAL-F51-2375 F51 Top</p> <table border="1"> <tr><td>Newel Post Designation</td><td>F51</td></tr> <tr><td>Turned Newel Size*</td><td>3 1/2" min.</td></tr> <tr><td>Shown with Newel</td><td>N/A</td></tr> </table>	Newel Post Designation	F51	Turned Newel Size*	3 1/2" min.	Shown with Newel	N/A	<p>FINIAL-F78-325 F78 Top</p> <table border="1"> <tr><td>Newel Post Designation</td><td>F78</td></tr> <tr><td>Turned Newel Size*</td><td>4 1/4" min.</td></tr> <tr><td>Shown with Newel</td><td>N/A</td></tr> </table>	Newel Post Designation	F78	Turned Newel Size*	4 1/4" min.	Shown with Newel	N/A	<p>FINIAL-F78CP-325 F78 w/Carved Pineapple Top</p> <table border="1"> <tr><td>Newel Post Designation</td><td>F78CP</td></tr> <tr><td>Turned Newel Size*</td><td>4 1/4" min.</td></tr> <tr><td>Shown with Newel</td><td>N/A</td></tr> </table>	Newel Post Designation	F78CP	Turned Newel Size*	4 1/4" min.	Shown with Newel	N/A
Newel Post Designation	F20																																	
Turned Newel Size*	3 1/2" min.																																	
Shown with Newel	N/A																																	
Newel Post Designation	F43																																	
Turned Newel Size*	5 1/4" min.																																	
Shown with Newel	N/A																																	
Newel Post Designation	F51																																	
Turned Newel Size*	3 1/2" min.																																	
Shown with Newel	N/A																																	
Newel Post Designation	F78																																	
Turned Newel Size*	4 1/4" min.																																	
Shown with Newel	N/A																																	
Newel Post Designation	F78CP																																	
Turned Newel Size*	4 1/4" min.																																	
Shown with Newel	N/A																																	

*The minimum turned newel width recommended for finial in size shown.

Note: Finials are turned on turned newels (not applied with a dowel). See box newels for maximum recommended finial base diameters.

Note: "see page numbers" can be found in our catalog Edition 4.0.



*** MADE IN THE USA ***

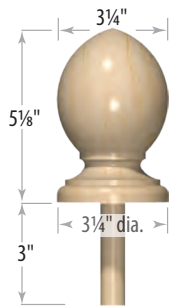

FINIAL-ASH-325
Ashley Top

Newel Post Designation	ASH
Turned Newel Size*	3 1/2" min.
Shown with Newel	page 104

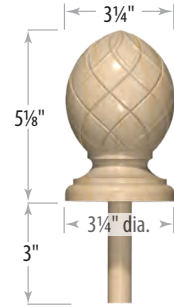

FINIAL-ASHCP-325
Ashley Carved Pineapple Top

Newel Post Designation	ASHCP
Turned Newel Size*	3 1/2" min.
Shown with Newel	N/A

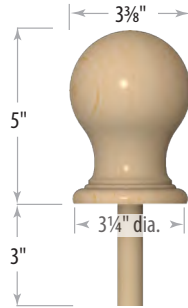

FINIAL-F88-325
F88 Top

Newel Post Designation	F88
Turned Newel Size*	3 1/2" min.
Shown with Newel	page 82

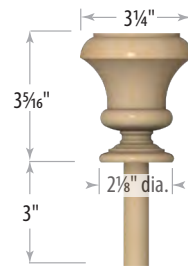

FINIAL-F84-2125
F84 Top

Newel Post Designation	F84
Turned Newel Size*	3 1/2" min.
Shown with Newel	N/A

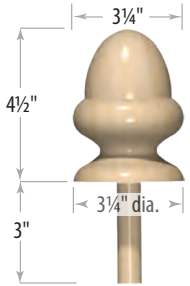

FINIAL-AT-325
Acorn Top

Newel Post Designation	AT
Turned Newel Size*	3 1/2" min.
Shown with Newel pgs	166,170,174



FINIAL-ATX-325
Acorn Etched Top

Newel Post Designation	ATX
Turned Newel Size*	3 1/2" min.
Shown with Newel	N/A

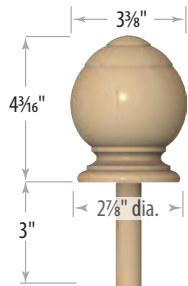

FINIAL-ATH-2875
Athena Top

Newel Post Designation	ATH
Turned Newel Size*	3 1/2" min.
Shown with Newel pgs	140,144,148



FINIAL-BT-325
Ball Top

Newel Post Designation	BT
Turned Newel Size*	3 1/2" min.
Shown with Newel pgs	162,175,176,180



FINIAL-BTB-325
Ball Top Beaded

Newel Post Designation	BTB
Turned Newel Size*	3 1/2" min.
Shown with Newel pgs	39,42



FINIAL-BTP-325
Ball Top Pineapple

Newel Post Designation	BTP
Turned Newel Size*	3 1/2" min.
Shown with Newel	N/A



FINIAL-BTR-325
Ball Top Reeded

Newel Post Designation	BTR
Turned Newel Size*	3 1/2" min.
Shown with Newel	N/A

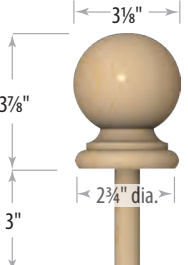

FINIAL-CBT-275
Clifton Park Ball Top

Newel Post Designation	CBT
Turned Newel Size*	3 1/2" min.
Shown with Newel	page 108



FINIAL-CBTP-275
Clifton Park Ball Top Pineapple

Newel Post Designation	CBTP
Turned Newel Size*	3 1/2" min.
Shown with Newel	N/A

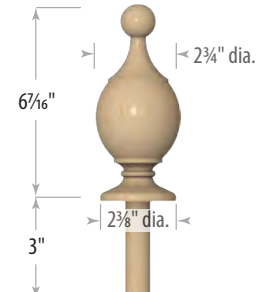

FINIAL-CHAB-2375
Chablis Top

Newel Post Designation	CHAB
Turned Newel Size*	3" min.
Shown with Newel	N/A

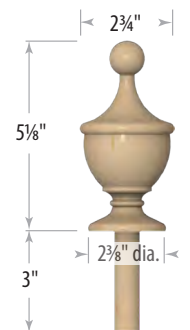

FINIAL-CHAM-2375
Champagne Top

Newel Post Designation	CHAM
Turned Newel Size*	3" min.
Shown with Newel	N/A

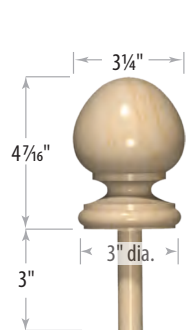

FINIAL-COL-300
Colonial Top

Newel Post Designation	COL
Turned Newel Size*	3 1/2" min.
Shown with Newel	page 176

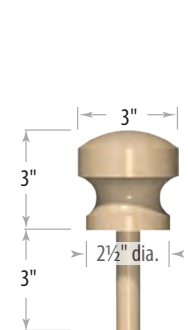

FINIAL-DOM-250
Dome Top

Newel Post Designation	DOM
Turned Newel Size*	3 1/4" min.
Shown with Newel	page 128

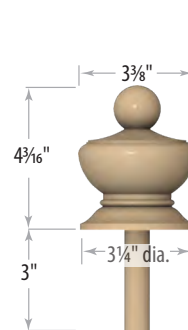

FINIAL-ESN90-325
Beret Top

Newel Post Designation	ESN90
Turned Newel Size*	3 1/2" min.
Shown with Newel	page 40

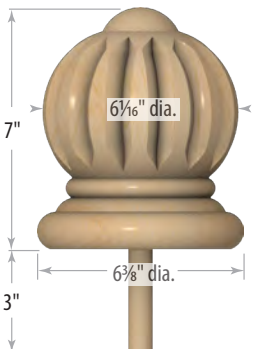

FINIAL-ESN100-6375
ESN100 Reeded Ball Top

Newel Post Designation	ESN100
Turned Newel Size*	6 3/4" min.
Shown with Newel	page 40

*The minimum turned newel width recommended for finial in size shown.

Note: Finials are turned on turned newels (not applied with a dowel). See box newels for maximum recommended finial base diameters.

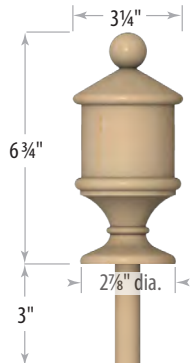

FINIAL-LIGH-2875
Lighthouse Top

Newel Post Designation	LIGH
Turned Newel Size*	3 1/2" min.
Shown with Newel	N/A



FINIAL-PORT-325
Portsmouth Top

Newel Post Designation	PORT
Turned Newel Size*	3 1/2" min.
Shown with Newel	page 79

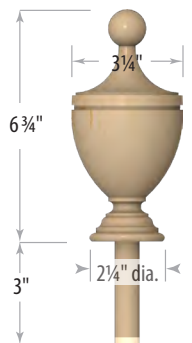

FINIAL-URN-225
Urn Top

Newel Post Designation	URN
Turned Newel Size*	3 1/2" min.
Shown with Newel	N/A

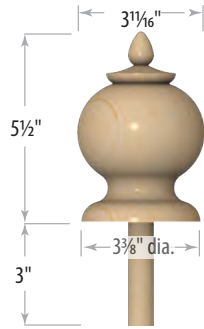

FINIAL-ESN155-3375
Ball with Lip Top

Newel Post Designation	ESN155
Turned Newel Size*	4" min.
Shown with Newel	page 41



FINIAL-FED-3125
Federal Top

Newel Post Designation	FED
Turned Newel Size*	3 1/2" min.
Shown with Newel	pgs 100,102

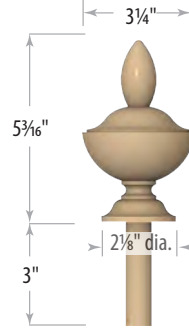

FINIAL-FLA-2125
Flame Top

Newel Post Designation	FLA
Turned Newel Size*	3 1/2" min.
Shown with Newel	N/A

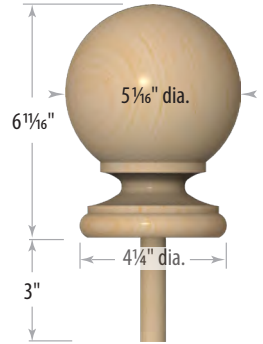

FINIAL-LBT-425
Large Ball Top

Newel Post Designation	LBT
Turned Newel Size*	4 1/2" min.
Shown with Newel	page 54

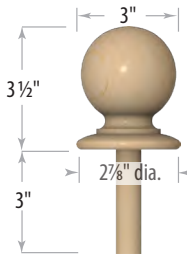

FINIAL-MBT-2875
Milan Ball Top

Newel Post Designation	MBT
Turned Newel Size*	3 1/4" min.
Shown with Newel	page 124

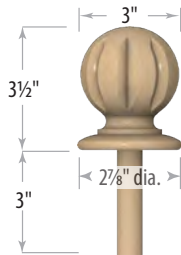

FINIAL-MBTR-2875
Milan Ball Top Reeded

Newel Post Designation	MBTR
Turned Newel Size*	3 1/4" min.
Shown with Newel	N/A

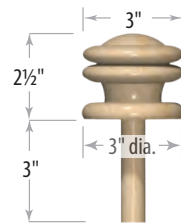

FINIAL-MET-300
Metro Top

Newel Post Designation	MET
Turned Newel Size*	3 1/4" min.
Shown with Newel	pgs 120,122

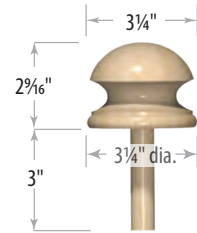

FINIAL-MT-325
Mushroom Top

Newel Post Designation	MT
Turned Newel Size*	3 1/2" min.
Shown with Newel	pgs 181,184

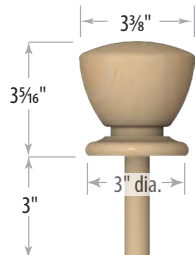

FINIAL-REG-300
Regency Top

Newel Post Designation	REG
Turned Newel Size*	3 1/2" min.
Shown with Newel	page 112

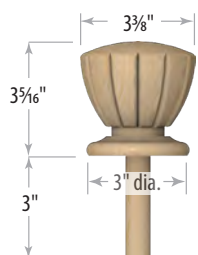

FINIAL-REGR-300
Regency Top Reeded

Newel Post Designation	REGR
Turned Newel Size*	3 1/2" min.
Shown with Newel	page 112

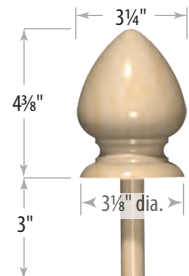

FINIAL-ST-3125
Spade Top

Newel Post Designation	ST
Turned Newel Size*	3 1/2" min.
Shown with Newel	page 176

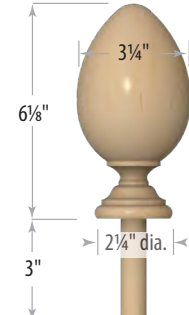

FINIAL-TEA-225
Teardrop Top

Newel Post Designation	TEA
Turned Newel Size*	3 1/2" min.
Shown with Newel	N/A

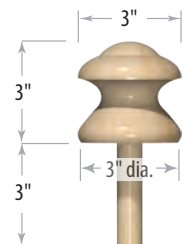

FINIAL-TEM-300
Tempo Top

Newel Post Designation	TEM
Turned Newel Size*	3 1/4" min.
Shown with Newel	page 116

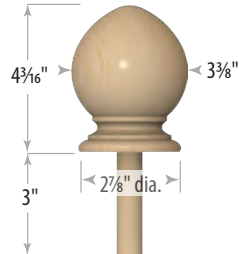

FINIAL-VEN-2875
Venus Top

Newel Post Designation	VEN
Turned Newel Size*	3 1/2" min.
Shown with Newel	pgs 141,145,149

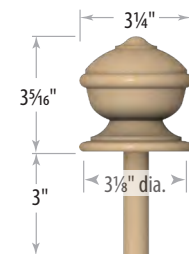

FINIAL-VIC-3125
Victoria Top

Newel Post Designation	VIC
Turned Newel Size*	3 1/2" min.
Shown with Newel	pgs 93,94

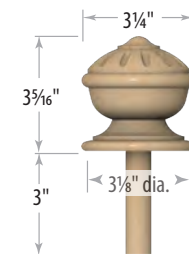

FINIAL-VICF-3125
Victoria Top Fluted

Newel Post Designation	VICF
Turned Newel Size*	3 1/2" min.
Shown with Newel	page 94

*The minimum turned newel width recommended for finial in size shown.

Note: Finials are turned on turned newels (not applied with a dowel). See box newels for maximum recommended finial base diameters.

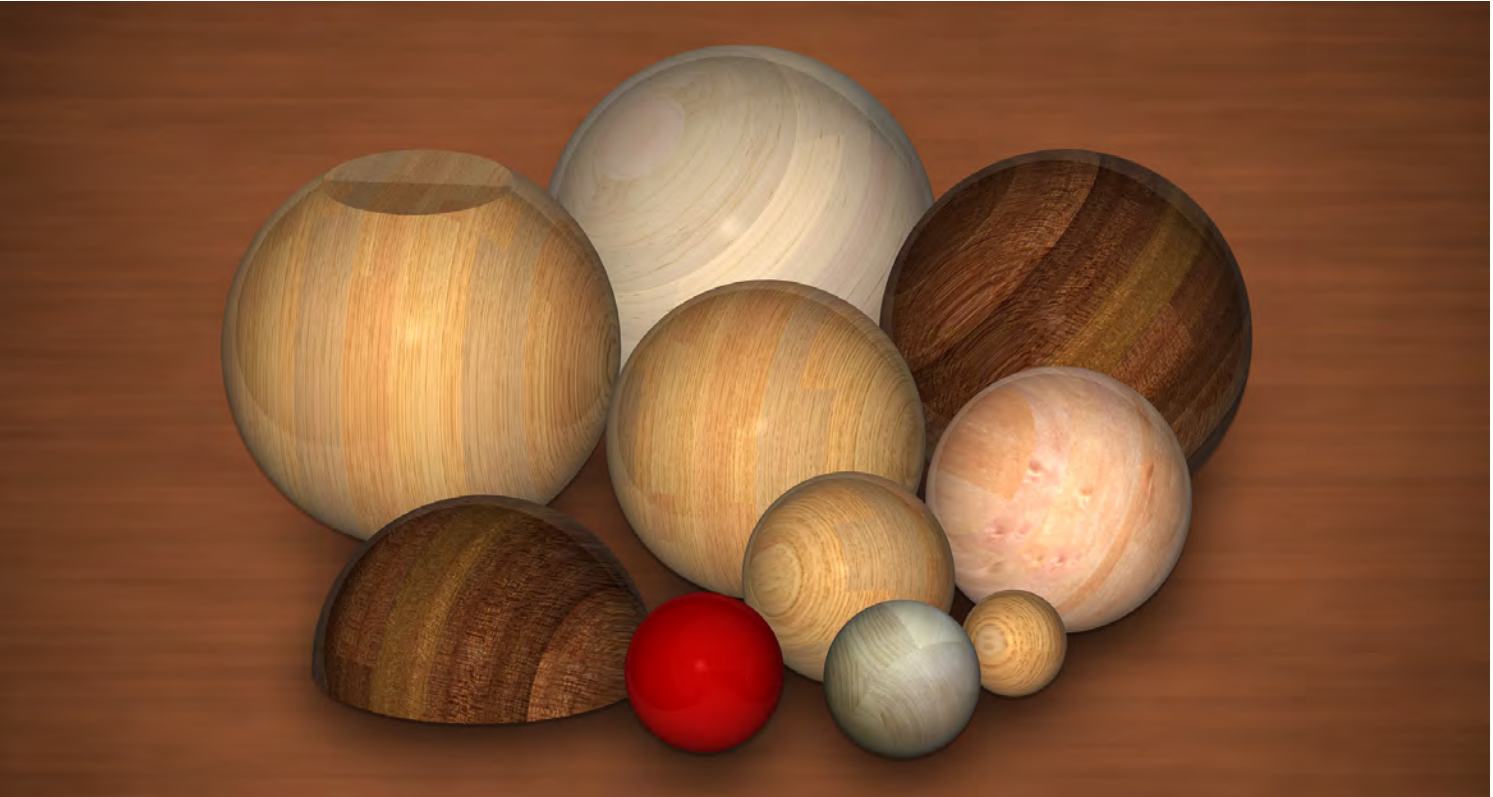

Note: Sizes measured in diameters



Laminated Wood Balls

Wood balls have a variety of uses. Choose from full round, half round (must be ordered in pairs) or round with flat(s). Please send drawing for balls with more than one flat. All available in our usual hardwood species and more.



Rope Moulding

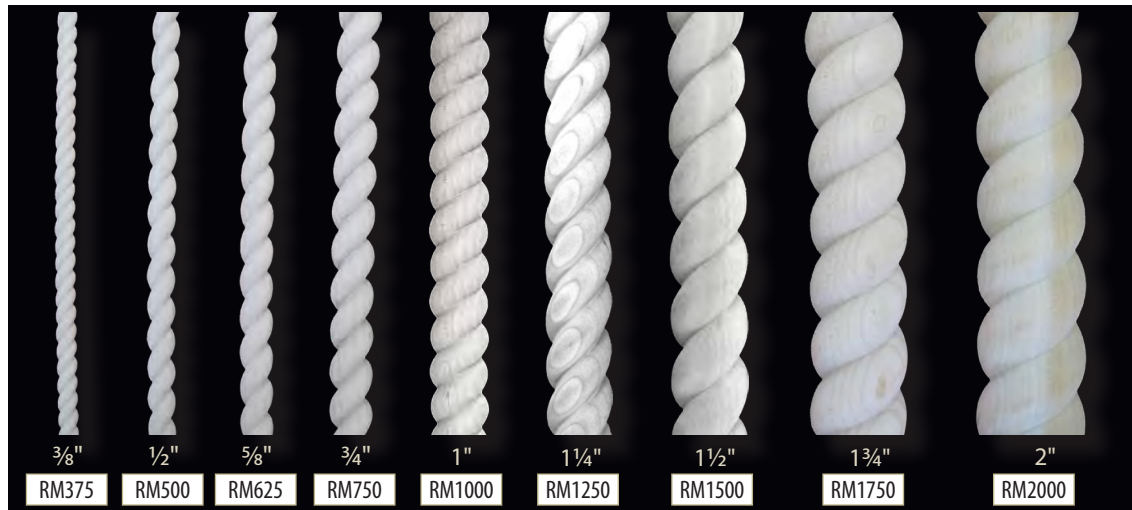

Rope Moulding Beaded



- Available standard or beaded rope
- Half round (shown), full round, quarter round, 3/4" round (outside corners)
- LH & RH ropes (RH shown)
- 3/8" to 2" standard length is 8', others available
- 3", 4" and much wider available (also see our columns) Large ropes will vary in design from ropes 2" & smaller

S4S boards are sold in random lengths 3' to 16' or you may specify lengths for an upcharge on part or all of your order. Lengths are subject to availability of lumber. **Boards are also available for radius windows and doors and for curved wall applications.**

S4S Boards

- Molded 4 sides
- Standard NET thicknesses are 3/4", 1 1/16", 1 5/16" and 1 3/4"
- Standard NET widths are:
1 1/2", 2 1/2", 3 1/2", 4 1/2", 5 1/2", 7 1/2", 9 1/2" and 11 1/2"
(boards may be edge glued for width)
- Availability varies by species

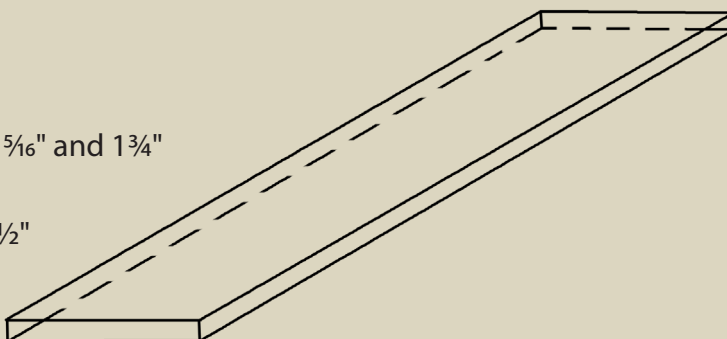

See shoe and cove moulding on
page 255 in our catalog Edition 4.0



OAK POINTE

WHERE TRADITION AND INNOVATION CREATE EXCELLENCE

96 NEW PACE ROAD
NEWCOMERSTOWN
OHIO 43832

P 740.498.9820

F 740.498.9821

GENERAL INQUIRY

INFO@STAIRPARTSANDMORE.COM

QUOTE REQUESTS

QUOTES@STAIRPARTSANDMORE.COM

SUBMIT ORDERS

ORDERS@STAIRPARTSANDMORE.COM

Connect with us on:

