



OAK POINTE

# VICTORIA SERIES

DIAMOND COLLECTION



★★★ *MADE IN THE USA* ★★★

**The Victoria Series** is part of our Diamond Collection, designed and manufactured by Oak Pointe includes familiar & new products for stairways but with Oak Pointe's typical expanded options including parts for fireplaces, columns, kitchens and more. All components in this collection are for interior use only.

WHERE TRADITION AND INNOVATION CREATE EXCELLENCE

Custom components are an integral part of our business. Call for pricing on your designs for interior and exterior use.

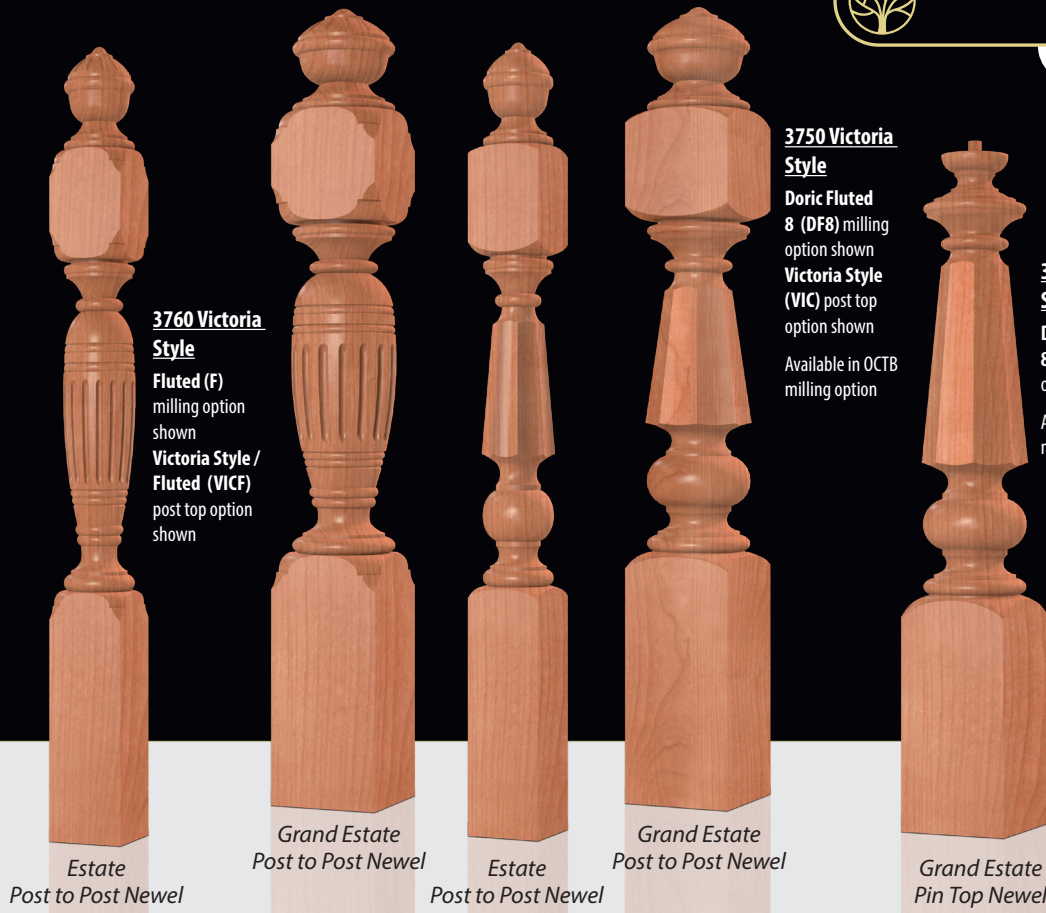

### Estate and Grand Estate Newel Dimensions

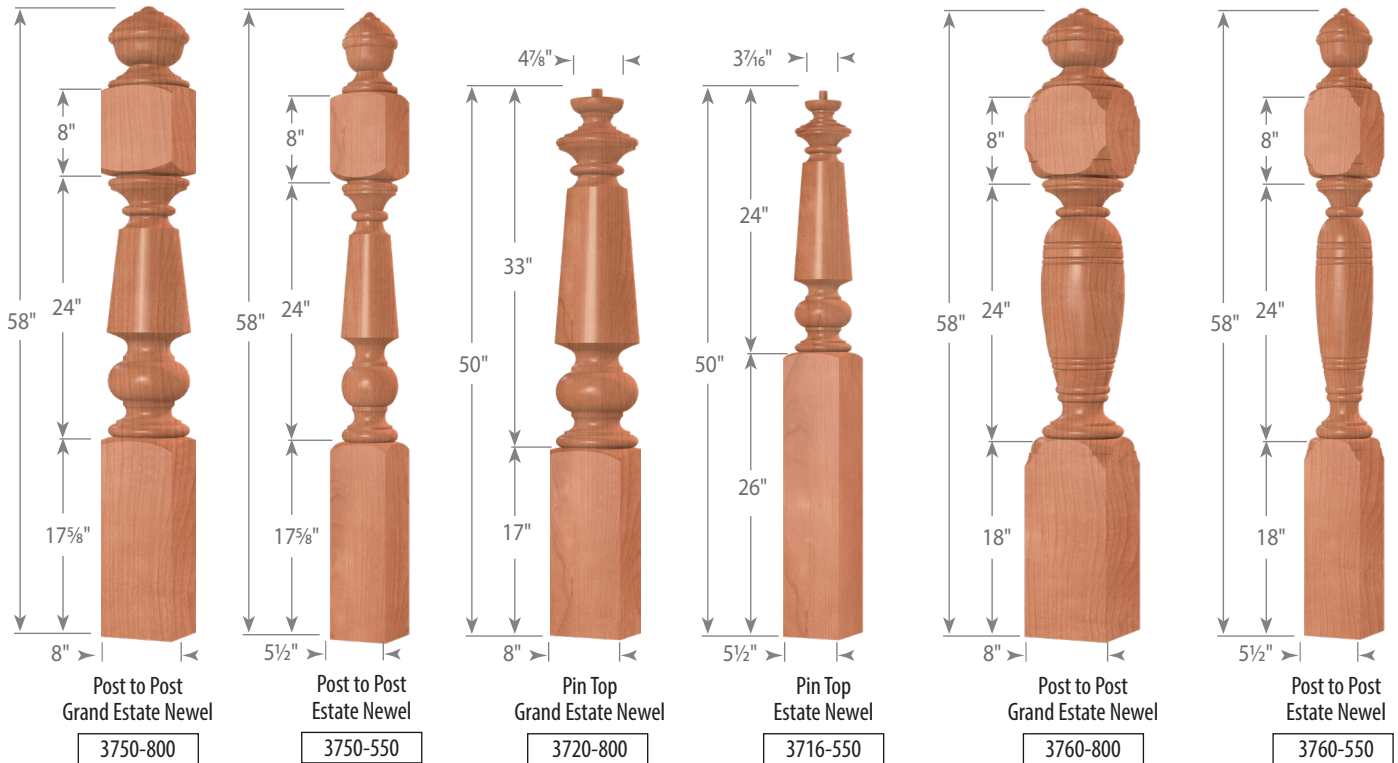

Post to Post Newels shown with Victoria Top (VIC). See all Post Top options on pages 276-278 in our catalog Edition 4.0.





**Suggested Handrails**  
To complement Victoria Series stair parts. For more selections of flat bottom and plowed handrails, see pages 237-239 in our catalog Edition 4.0.

6210



6310



6400



6519



6710



6910



**Standard Thickness:**

Baluster	1 5/8", 1 3/4"
Newel	3 1/2"
Estate Newel	5 1/2", 8"
Kitchen Island	3 1/2", 5", 8"
Fireplace	4 1/2"

Other Widths Available

**Featured Milling Option:**

Doric Fluted 8 DF8

**Newel Dimensions**

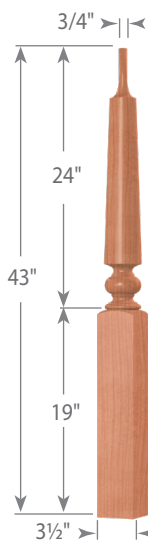

Pin Top Rake Newel

3713-350

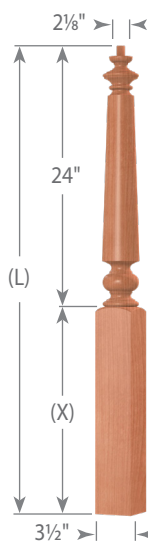

Pin Top Newel

Model	(L)	(X)
3710-350	43"	19"
3714-350	50"	26"
3715-350	58"	34"
3717-350	65"	41"
3718-350	73"	49"

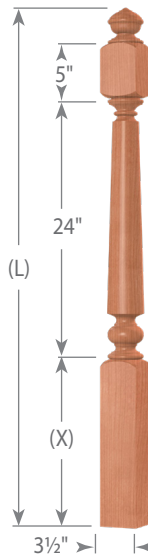

Post to Post Newel

Model	(L)	(X)
3740-350	48"	15 5/16"
3742-350	58"	25 5/16"
3753-350	62"	29 9/16"
3755-350	73"	40 5/16"
3758-350	78"	45 5/16"

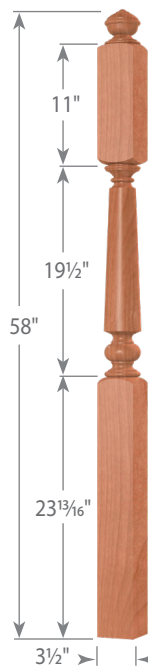

2nd Floor Landing Newel

3745-350

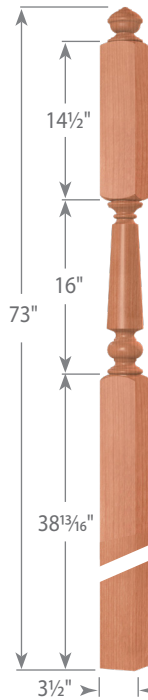

Intermediate Landing Newel

3746-350

**Victoria Tops**



Standard Top Fluted



Estate Top Fluted



Grand Estate Top Fluted

Post to Post Newels shown with Victoria Top (VIC). See all Post Top options on pages 276-278 in our catalog Edition 4.0.



### Baluster Dimensions

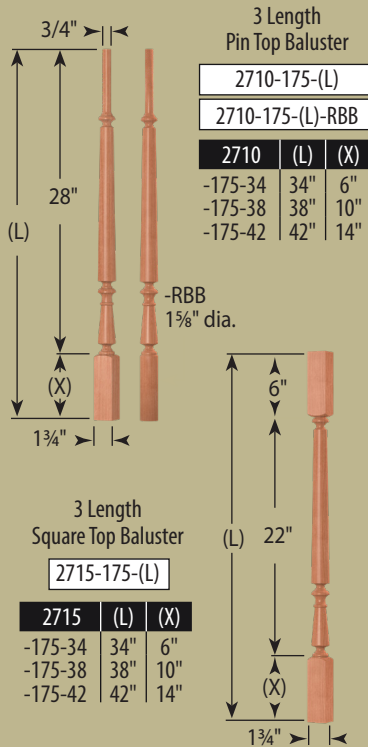

See page 32 in our catalog Edition 4.0 for 3 Length Baluster orientation on treads

**Wooden Dowel Pin**  
The bottom of each 3 length baluster is drilled and shipped with a loose wooden pin for installation. Optional steel dowel screws also available. Order #3076-100PK (pack of 100).

Milling Options	Doric Fluted 8	Octagon Barrel
Code	DF8	OCTB

### Pin Top Balusters

2710-175 (1 3/4" wide)

2710-175-RBB  
Round Bottom Block (1 5/8" dia.)

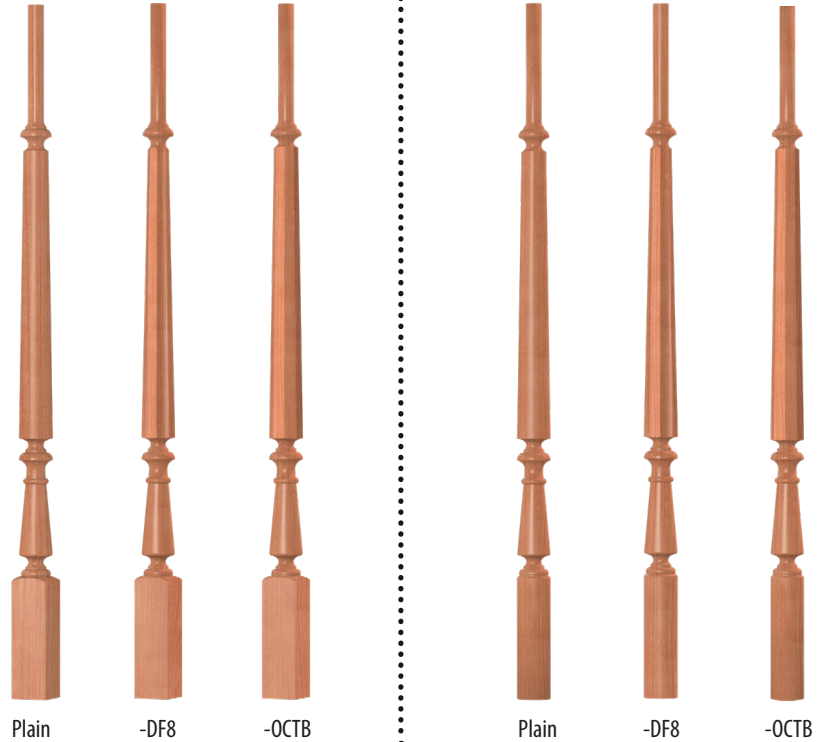

### Square Top Balusters 2715-175 (1 3/4" wide)

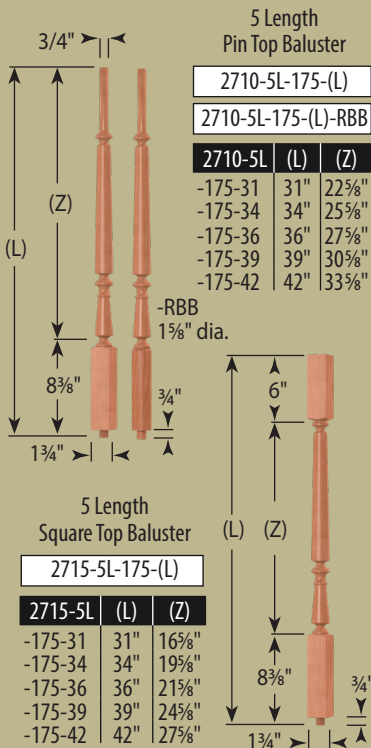
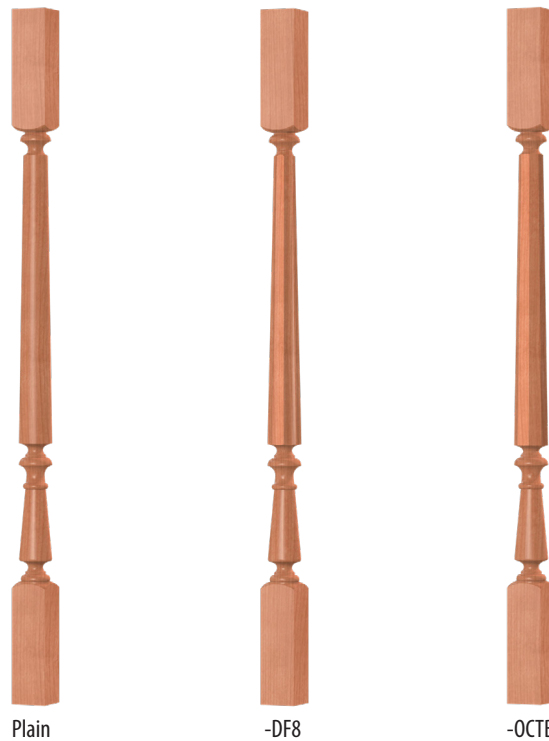

See page 32 in our catalog Edition 4.0 for 5 Length Baluster orientation on treads



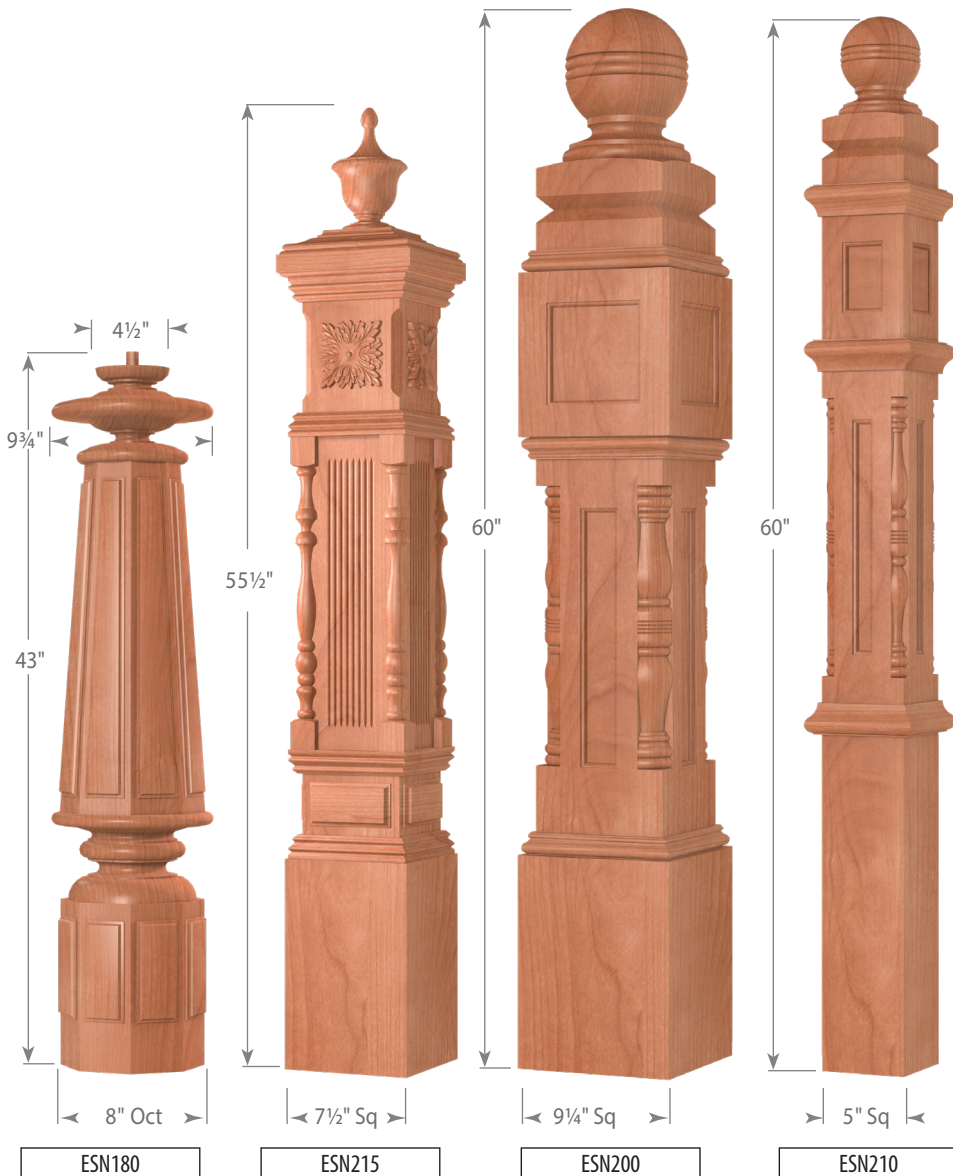

Baluster lengths may be ordered to fit your requirements. Available in 3 or 5 lengths.

**Wooden Dowel Pin**  
The bottom of each 3 length baluster is drilled and shipped with a loose wooden pin for installation. Optional steel dowel screws also available. Order #3076-100PK (pack of 100).

See page 32 in our catalog Edition 4.0 for 3 Length Baluster orientation on treads



## Legs and Island Columns

Island Column 12715-350 12715-500	Grand Estate Island Column 12715-800	Bar Leg (footed) 122715-350	Island Leg (footed) 102715-350 102715-500	Grand Estate Island Leg (footed) 102715-800	Table Leg (footed) 92715-350	Coffee Table Leg (footed) 82715-275	End Table Leg (footed) 72715-225	End Table Leg (w/stretch block) 62715-225	Island Column 13760-350 13760-500	Grand Estate Island Column 13760-800
---	---	--------------------------------	---	--	---------------------------------	--	-------------------------------------	--	---	---

Victoria Grand Estate Island Column Examples

12715-800-DF8      13760-800-F

### Bun Foot

52715

**Victoria Series Bun Foot**  
For more Bun Feet selections, see pages 274-275.

### Milling Options

Milling Options Details

Name	Doric Fluted 8	Fluted*	Octagon Barrel
Code	DF8	F	OCTB

MILLING OPTIONS	CODE	Island Column	Legs	Bun Feet	Interior Post	Fireplace Column	Decorative Column
Doric Fluted 8	DF8	✓	✓		✓	✓	✓
Fluted*	F	✓			✓	✓	✓
Octagon Barrel	OCTB	✓	✓		✓	✓	✓

\*3760 Series only

\*3760 Series only



## Fireplace Columns

### Interior Posts

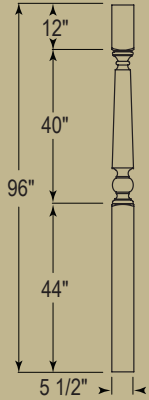

Standard post size is 5 1/2" wide and 96" high.



Interior Post  
Shown Plain

42715-550

Our columns and posts have not been tested for their weight bearing ability and therefore are sold as NON-weight bearing.

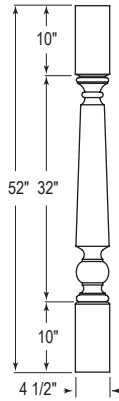
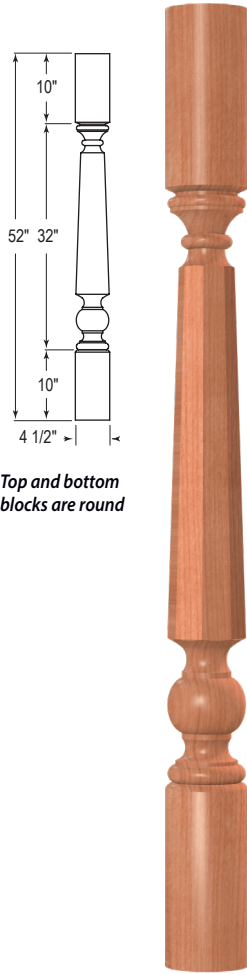

Top and bottom blocks are round

Fireplace Column Example

22715-450-0CTB

### Tuscan Base

used for Cap and Base (optional)



Model No. BASETUS450

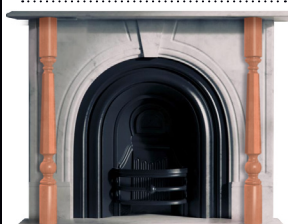
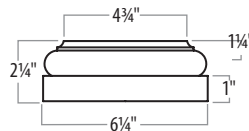

Fireplace columns shown with Doric Fluted 8 milling option.

See pages 288-289 for more Fireplace Columns

### Decorative Solid Round Columns

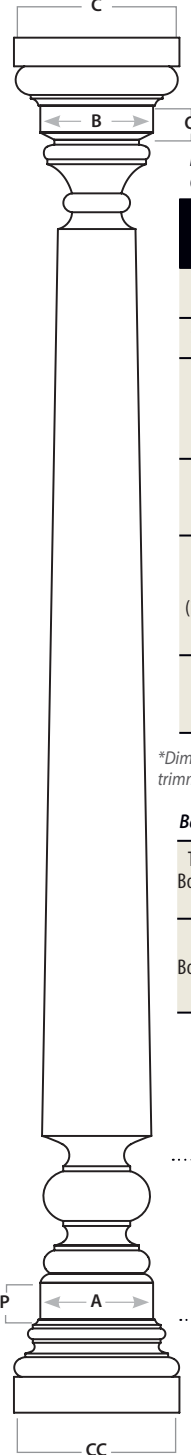

#### Decorative Solid Round Column Dimensions\*

Column Size	550	750	950
Bottom Dia. "A"	5 1/2"	7 1/2"	9 1/2"
Top Dia. "B"	5 1/2"	7 1/2"	9 1/2"
Round Bottom Block Height "P"	2"	2 5/8"	3 3/8"
Round Top Block Height "Q"	1 1/2"	2"	2 1/2"
Standard Lengths (including cap & base)	6' 7' 8'	6' 7' 8' 9' 10'	6'
Cap & Base Included	Attic Base with Tuscan Base for Cap		

\*Dimensions shown are after final field trimming of shaft bottom.

#### Base/Cap Dimensions

Tuscan Base Bottom Square Width "C"	9"	11"	13"
Attic Base Bottom Square Width "CC"	9"	11"	13"



Tuscan Base used for Cap



Attic Base

See page 284 for all Base and Cap dimensions

7 1/2" x 96"  
Victoria Series  
Column with Cap  
and Attic Base  
Example

32715-750-96-DF8

NOTE: These columns are manufactured from solid blanks with face and edge grain.

See pages 282-283 in our catalog Edition 4.0 for more Columns







### Interior Posts

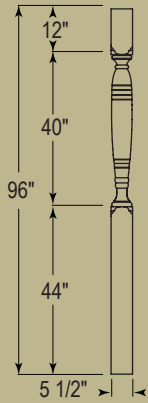

Standard post size is 5 1/2" wide and 96" high.



Interior Post Shown Plain

43760-550

Our columns and posts have not been tested for their weight bearing ability and therefore are sold as NON-weight bearing.

### Fireplace Columns

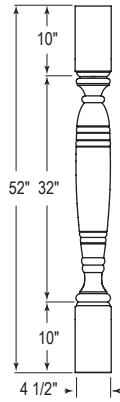

Top and bottom blocks are round



Fireplace Column Example

23760-450-F

#### Tuscan Base used for Cap and Base (optional)



Model No. BASETUS450

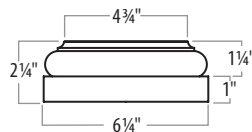

Fireplace Columns shown with Fluted milling option.

See pages 288-289 in our catalog Edition 4.0 for more Fireplace Columns

### Decorative Solid Round Columns

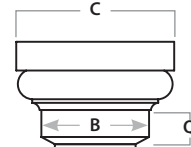

#### Decorative Solid Round Column Dimensions\*

Column Size	550	750	950
Bottom Dia. "A"	5 1/2"	7 1/2"	9 1/2"
Top Dia. "B"	5 1/2"	7 1/2"	9 1/2"
Round Bottom Block Height "P"	2"	2 5/8"	3 3/8"
Round Top Block Height "Q"	1 1/2"	2"	2 1/2"
Standard Lengths (including cap & base)	6' 7' 8'	6' 7' 8' 9' 10'	6'
Cap & Base Included	Attic Base with Tuscan Base for Cap		

\*Dimensions shown are after final field trimming of shaft bottom.

#### Base/Cap Dimensions

Tuscan Base Bottom Square Width "C"	9"	11"	13"
Attic Base Bottom Square Width "CC"	9"	11"	13"



Tuscan Base used for Cap



Attic Base

See page 284 for all Base and Cap dimensions

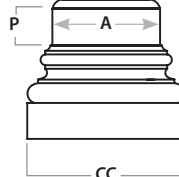

7 1/2" x 96" Victoria Series Column with Cap and Attic Base Example

33760-750-96-F

NOTE: These columns are manufactured from solid blanks with face and edge grain.

See pages 282-283 in our catalog Edition 4.0 for more Columns





# OAK POINTE

WHERE TRADITION AND INNOVATION CREATE EXCELLENCE

96 NEW PACE ROAD  
NEWCOMERSTOWN  
OHIO 43832

P 740.498.9820

F 740.498.9821

**GENERAL INQUIRY**

[INFO@STAIRPARTSANDMORE.COM](mailto:INFO@STAIRPARTSANDMORE.COM)

**QUOTE REQUESTS**

[QUOTES@STAIRPARTSANDMORE.COM](mailto:QUOTES@STAIRPARTSANDMORE.COM)

**SUBMIT ORDERS**

[ORDERS@STAIRPARTSANDMORE.COM](mailto:ORDERS@STAIRPARTSANDMORE.COM)

Connect with us on:

