

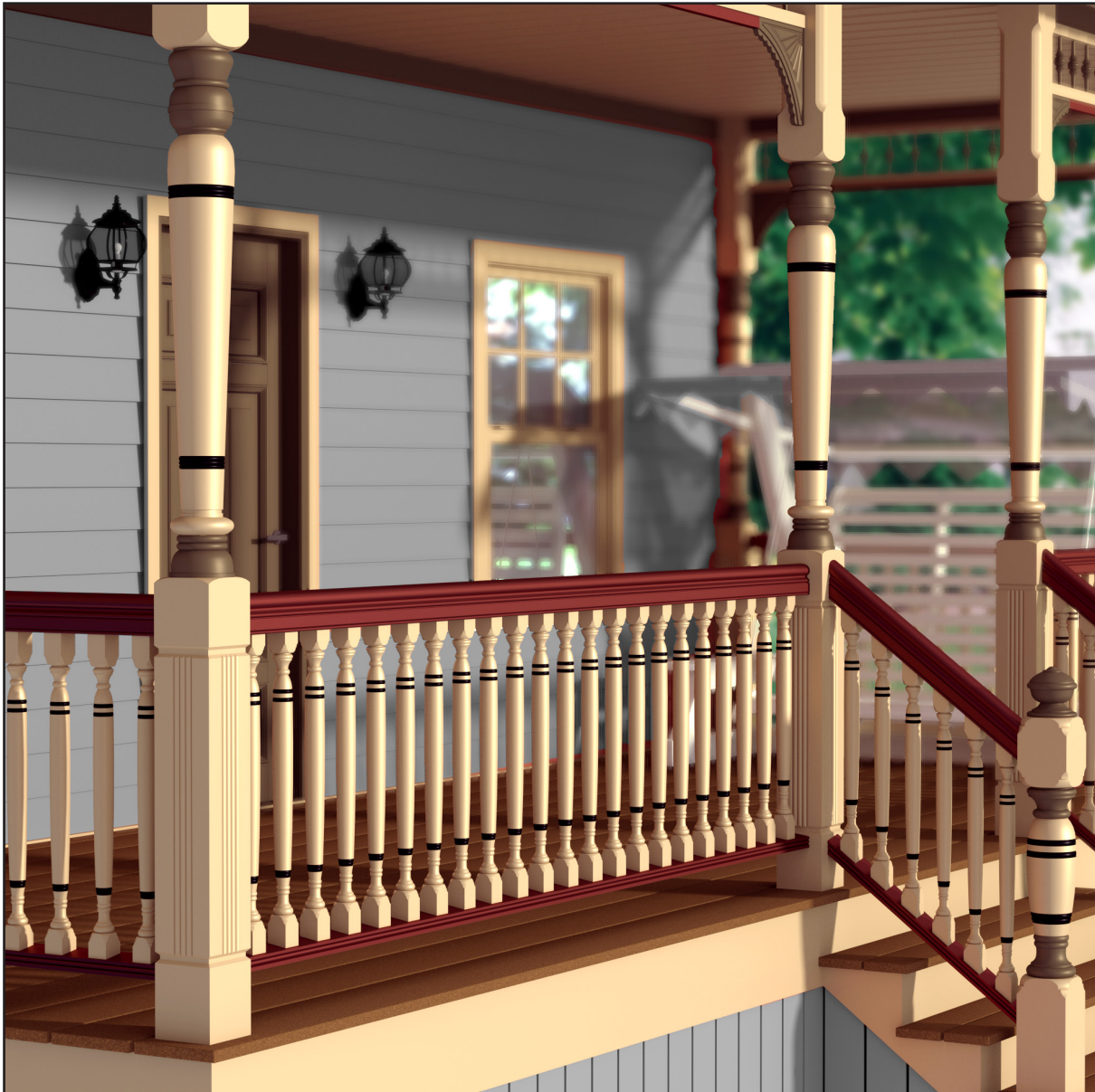

EXTERIOR COLLECTION

BALUSTERS • NEWELS • POSTS • RAILINGS • BRACKETS • SPINDLES



★ ★ ★ *MADE IN THE USA* ★ ★ ★

Exterior Collection from Oak Pointe: The exterior of your home will be stunning with a porch railing system designed and manufactured by Oak Pointe. Many components in other sections of this catalog can be manufactured for exterior use upon request.

WHERE TRADITION AND INNOVATION CREATE EXCELLENCE

Custom components are an integral part of our business. Call for pricing on your designs for interior and exterior use.



Our Exterior Collection components are offered in:



Accoya
(Coming in 2024)
Tested worldwide, Accoya is one of the best wood choices for exterior applications. See page 25 for more details.



Pine-Southern Yellow
The heartwood is orange to reddish-brown & the sapwood is yellowish white. Boards have contrasting colors - light early wood to darker denser latewood. Stronger than other pines with straight grain & medium even texture. (Available in paint grade.)



Sapelle
The heartwood of Sapelle is pink when freshly cut, but it matures to a medium to dark red-brown. The sapwood is grayish-pink or cream in color. The grain is fine and moderately interlocked or wavy. (Available in paint grade.)



Cellular PVC
Cellular PVC trim is a wood replacement product which is different than normal PVC, enabling it to be cut and shaped like wood without wood's disadvantages. Not available in railings & certain turning designs.

Other wood species are available upon request. The key to a lasting wood exterior component system is to finish them with top rated exterior products during installation and when the top coat starts to break down it should be refinished.

Handrails w/Fillet for 3½" Balusters

XTR68P350/X6009

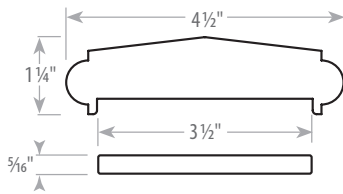

shown with X6009 fillet

Bottom Rails for 3½" Balusters

XBR65

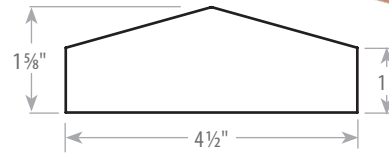

XTR78P350/X6009

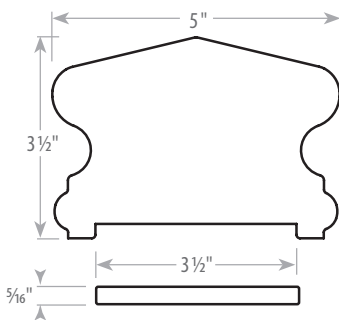

shown with X6009 fillet

XBR75

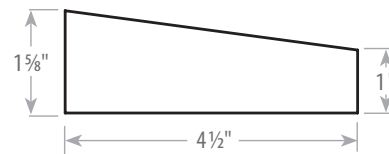

Handrail w/Fillet for 2" Balusters

XTR26P200/X6008

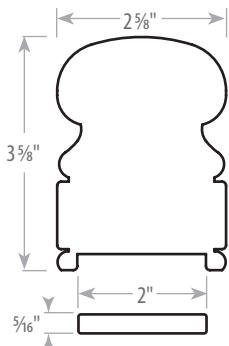

shown with X6008 fillet

Bottom Rail for 2" Balusters

XBR46

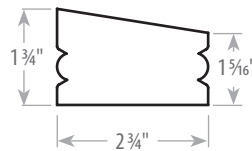

Exterior Products | These products will be made with exterior glue but no warranty for exterior use. Our columns and posts have not been tested for their weight bearing ability and therefore are sold as NON-weight bearing.



Exterior Baluster Dimensions

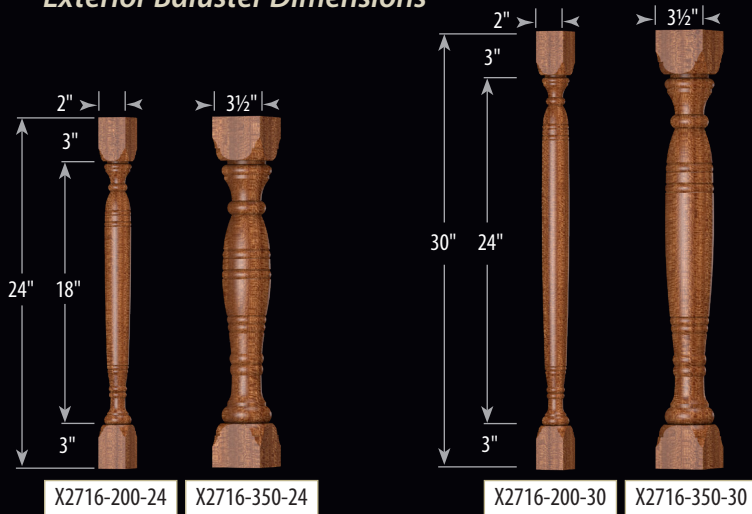

Exterior Post Dimensions



Exterior Newel Dimensions

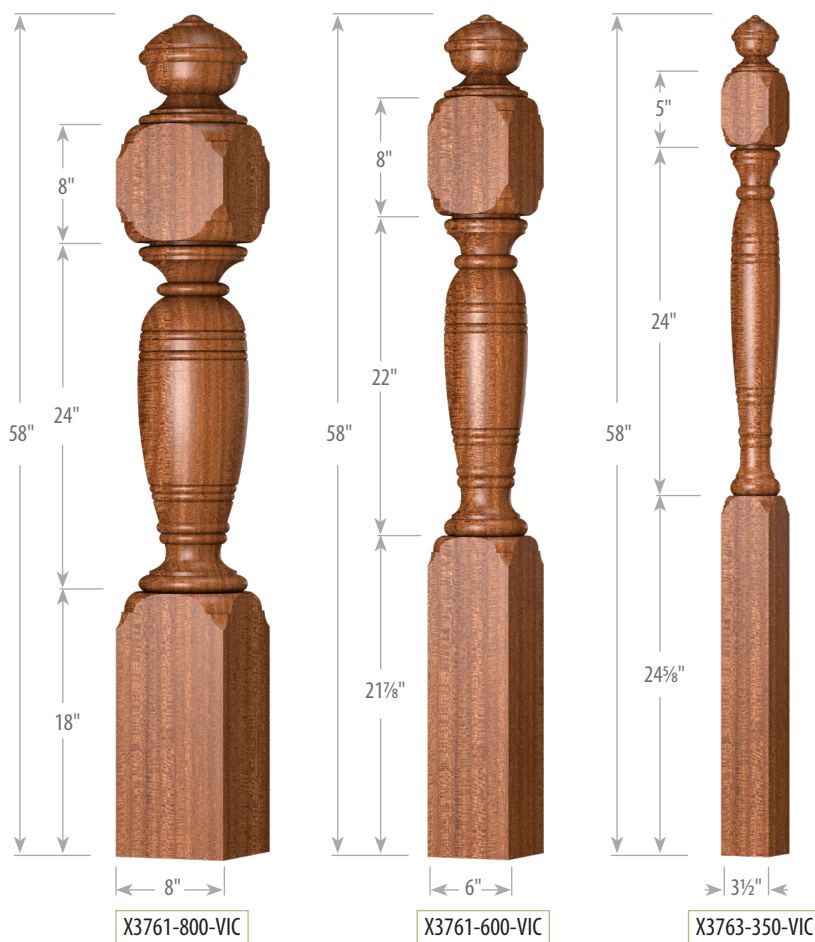

Exterior Products

These products will be made with exterior glue but no warranty for exterior use. Our columns and posts have not been tested for their weight bearing ability and therefore are sold as NON-weight bearing.



Exterior Post Dimensions

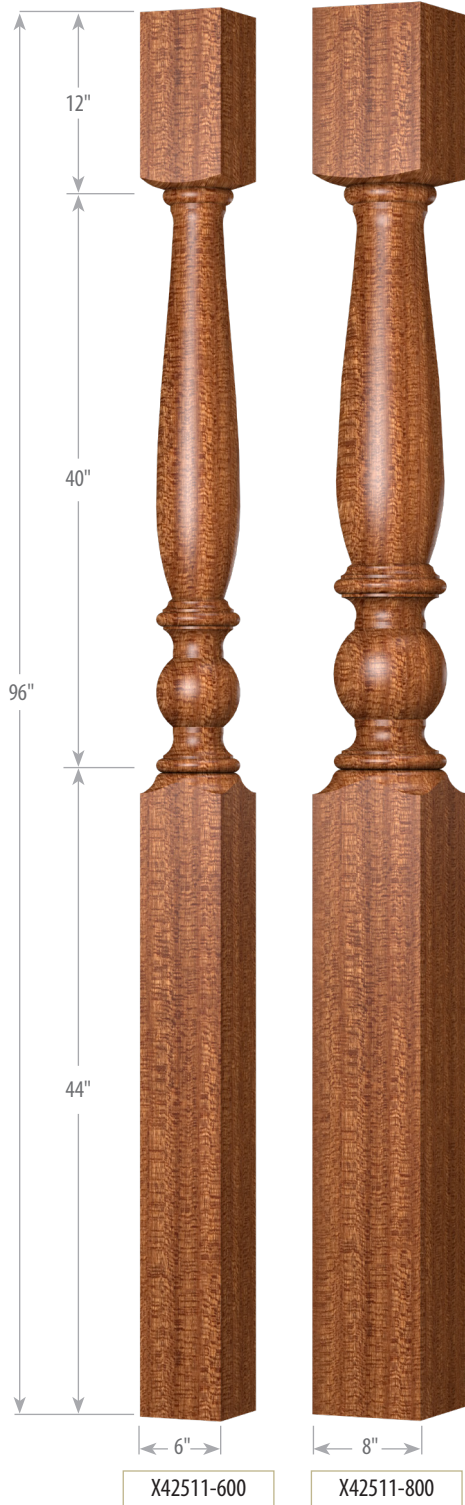

Exterior Baluster Dimensions

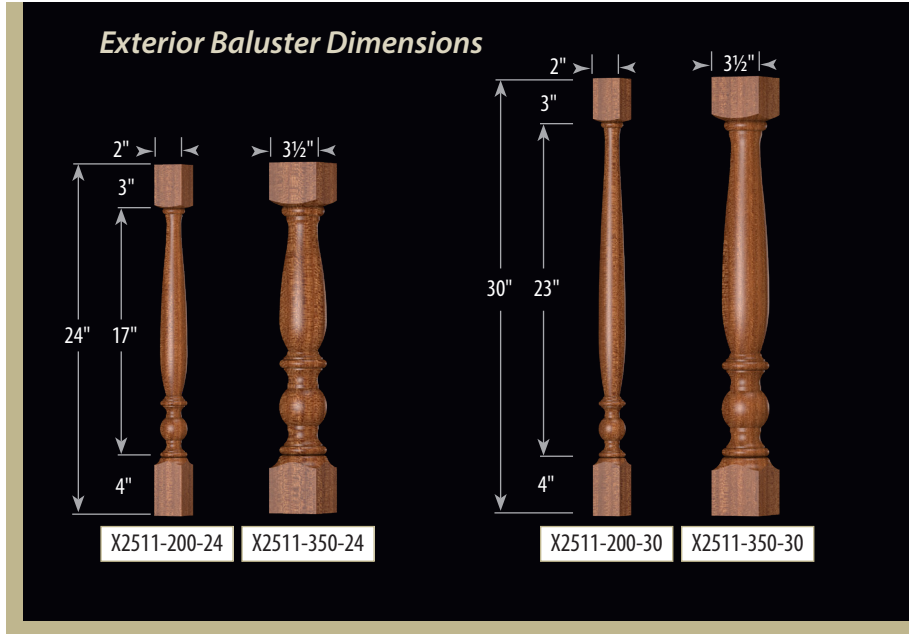

Exterior Newel Dimensions

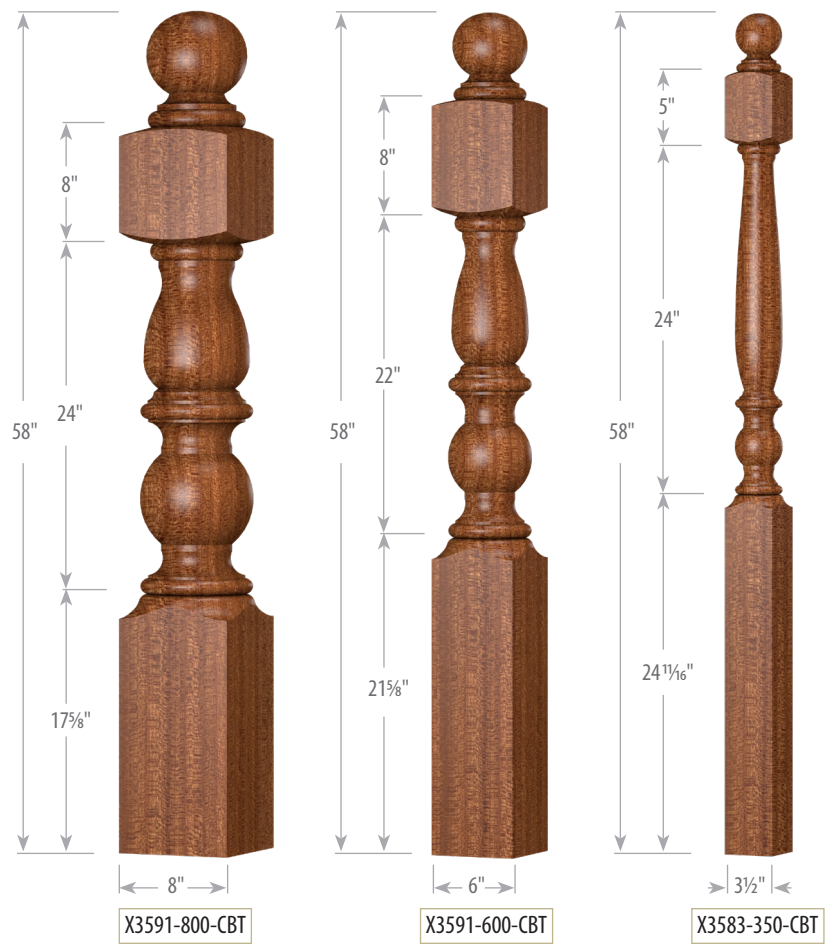

Exterior Products | These products will be made with exterior glue but no warranty for exterior use.
Our columns and posts have not been tested for their weight bearing ability and therefore are sold as NON-weight bearing.



Exterior Baluster Dimensions

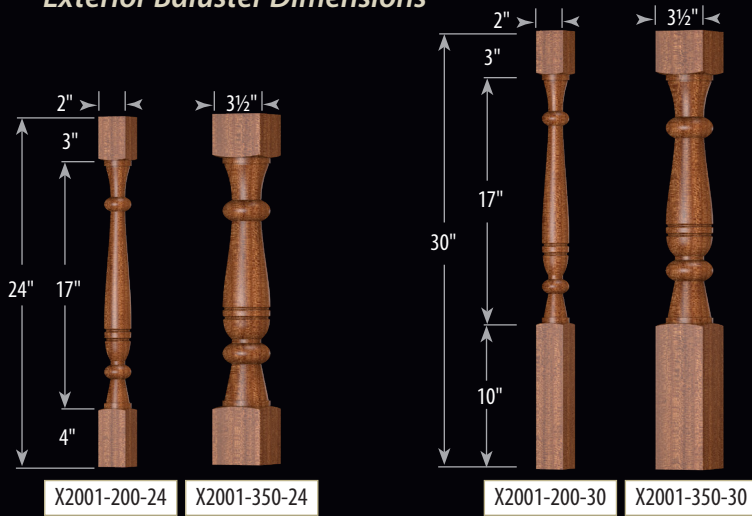

Exterior Post Dimensions



Exterior Newel Dimensions



Exterior Products

These products will be made with exterior glue but no warranty for exterior use. Our columns and posts have not been tested for their weight bearing ability and therefore are sold as NON-weight bearing.



Exterior Post Dimensions

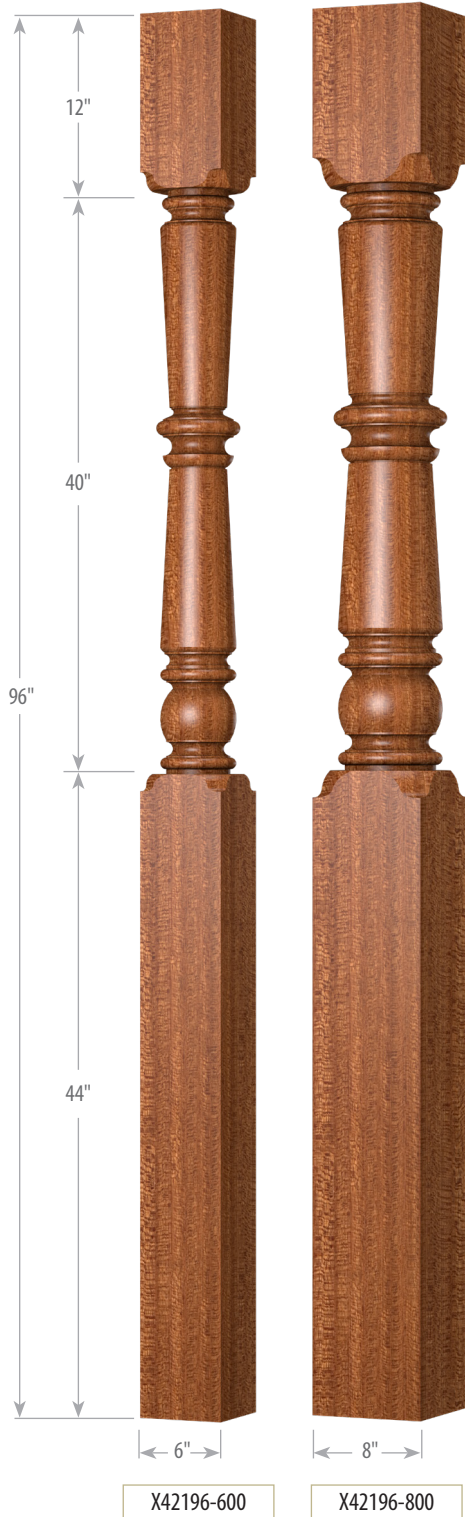

Exterior Baluster Dimensions

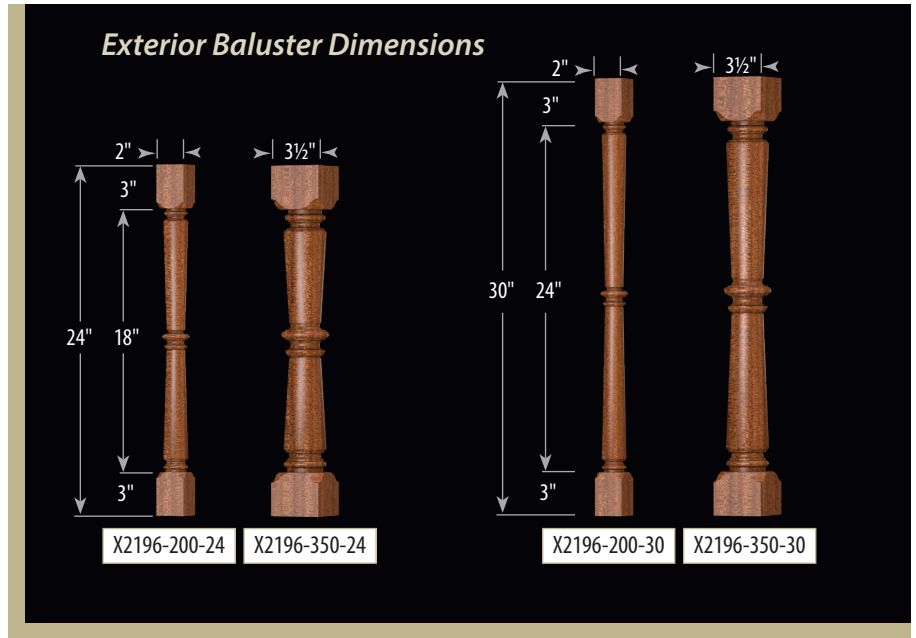

Exterior Newel Dimensions

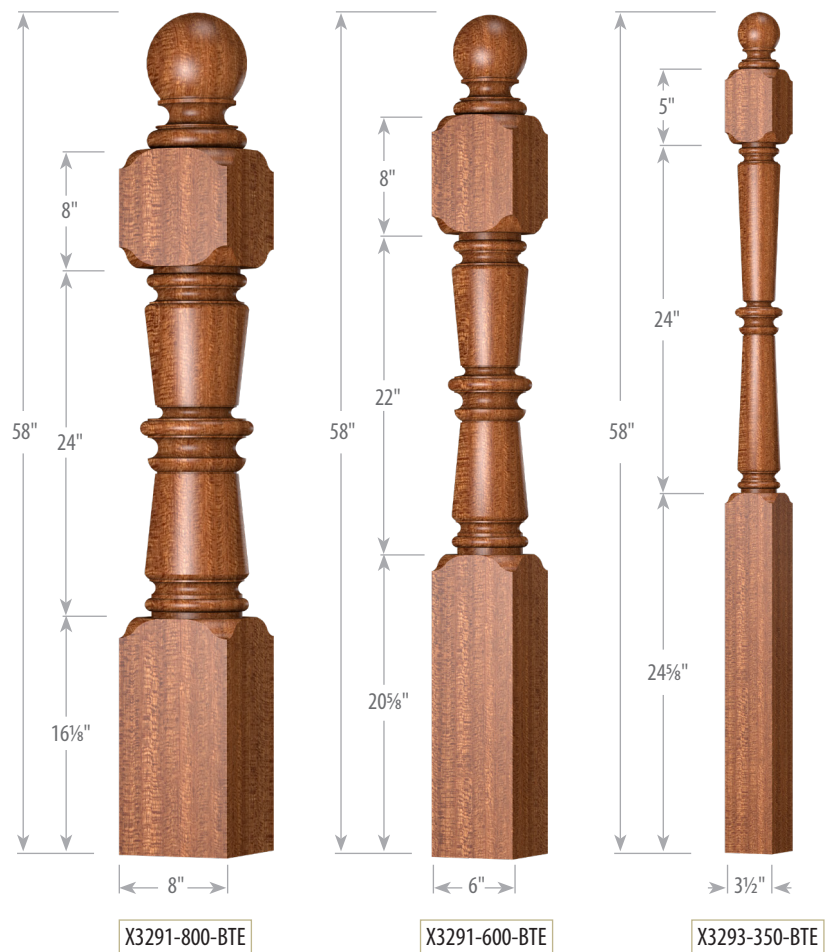

Exterior Products | These products will be made with exterior glue but no warranty for exterior use.
Our columns and posts have not been tested for their weight bearing ability and therefore are sold as NON-weight bearing.



The Exterior Posts on these pages are in addition to our four series Posts shown on the previous pages. These Oak Pointe designs were inspired by research done during visits to century and historic homes on the east coast.

All posts on this page are 6" square but are also available in other widths and lengths.



X46500-600

6" Square

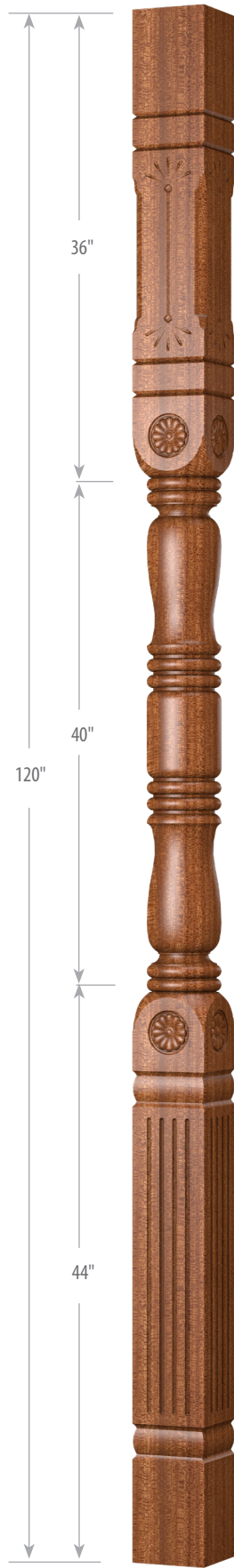

X46600-600

6" Square

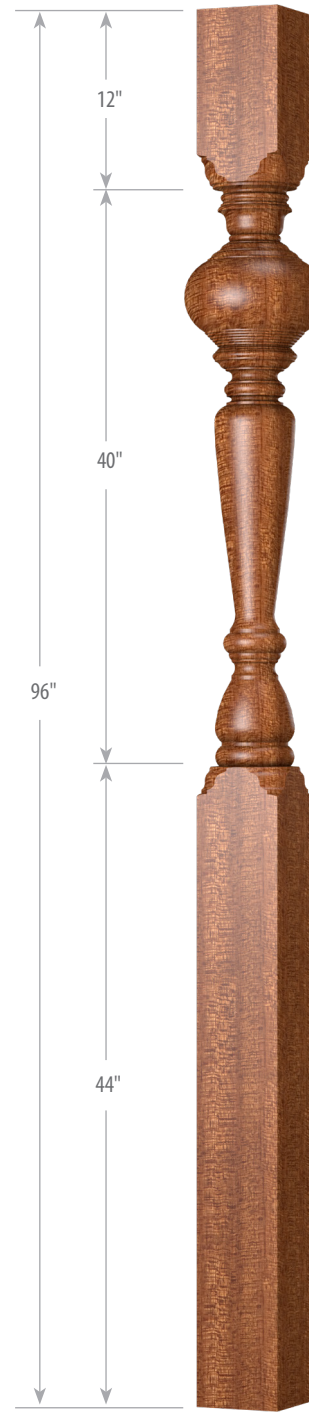

X46400-600

6" Square

Sphere
width
9 1/16" dia.



X46610-600

6" Square

Exterior Products

These products will be made with exterior glue but no warranty for exterior use. Our columns and posts have not been tested for their weight bearing ability and therefore are sold as NON-weight bearing.

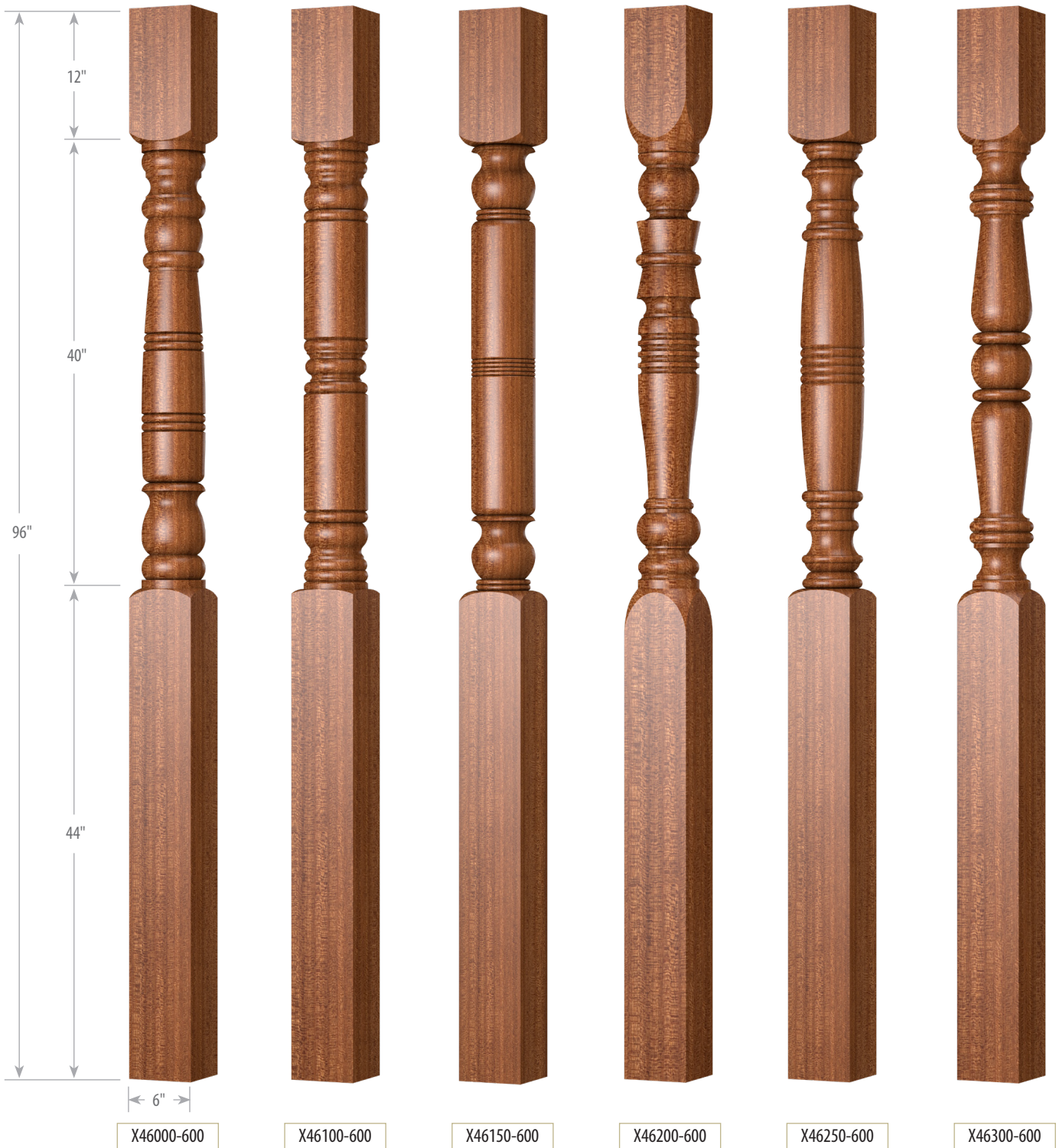

**Exterior
Products**

These products will be made with exterior glue but no warranty for exterior use.
Our columns and posts have not been tested for their weight bearing ability and therefore are sold as NON-weight bearing.

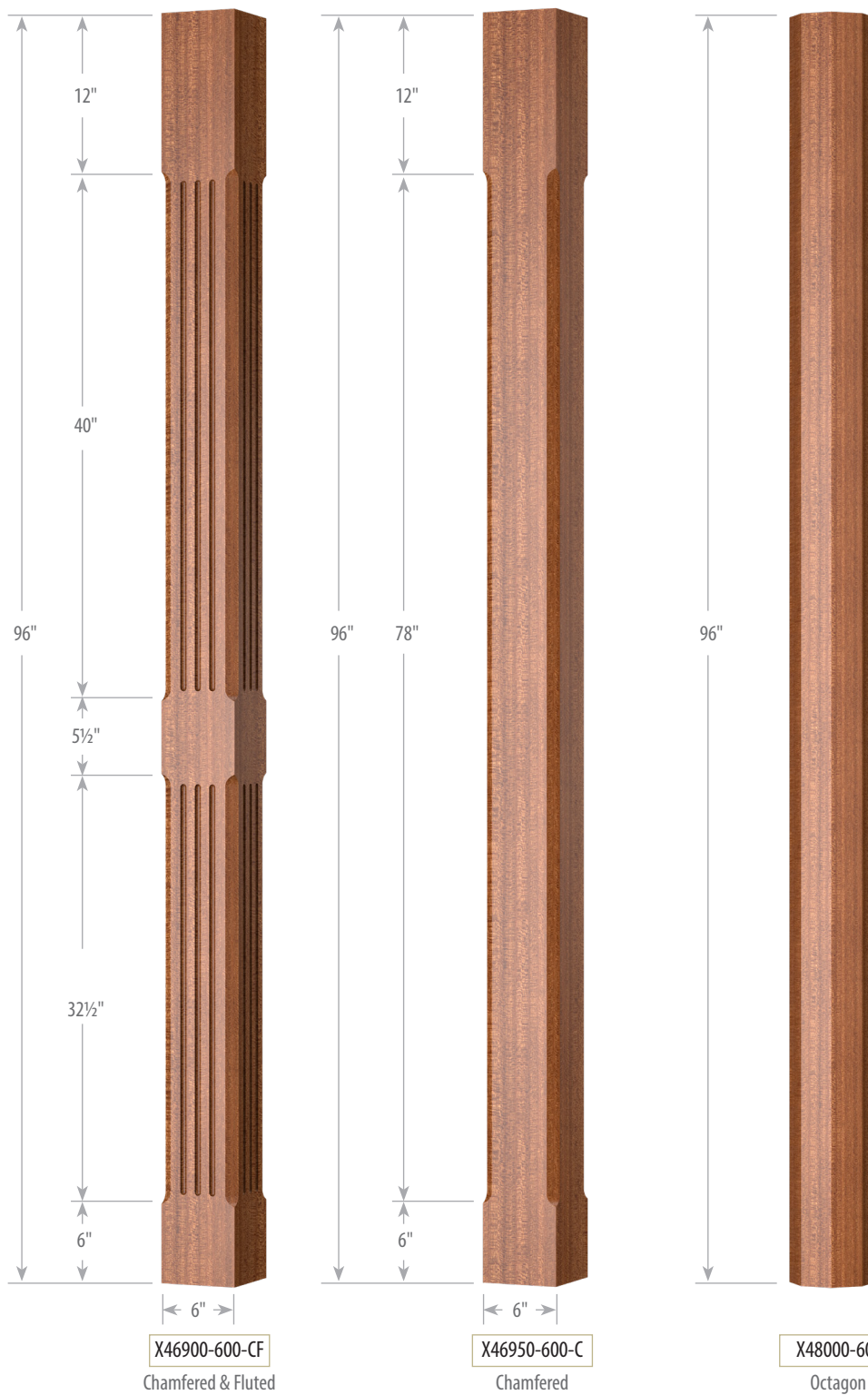

The Exterior Posts on these pages are in addition to our four series Posts shown on the previous pages. These Oak Pointe designs were inspired by research done during visits to century and historic homes on the east coast.

All posts on this page are 6" but are also available in other widths and lengths.

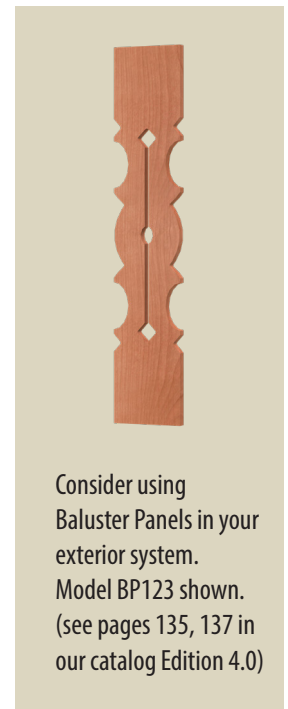

Exterior Products

These products will be made with exterior glue but no warranty for exterior use. Our columns and posts have not been tested for their weight bearing ability and therefore are sold as NON-weight bearing.



Exterior Corner Brackets

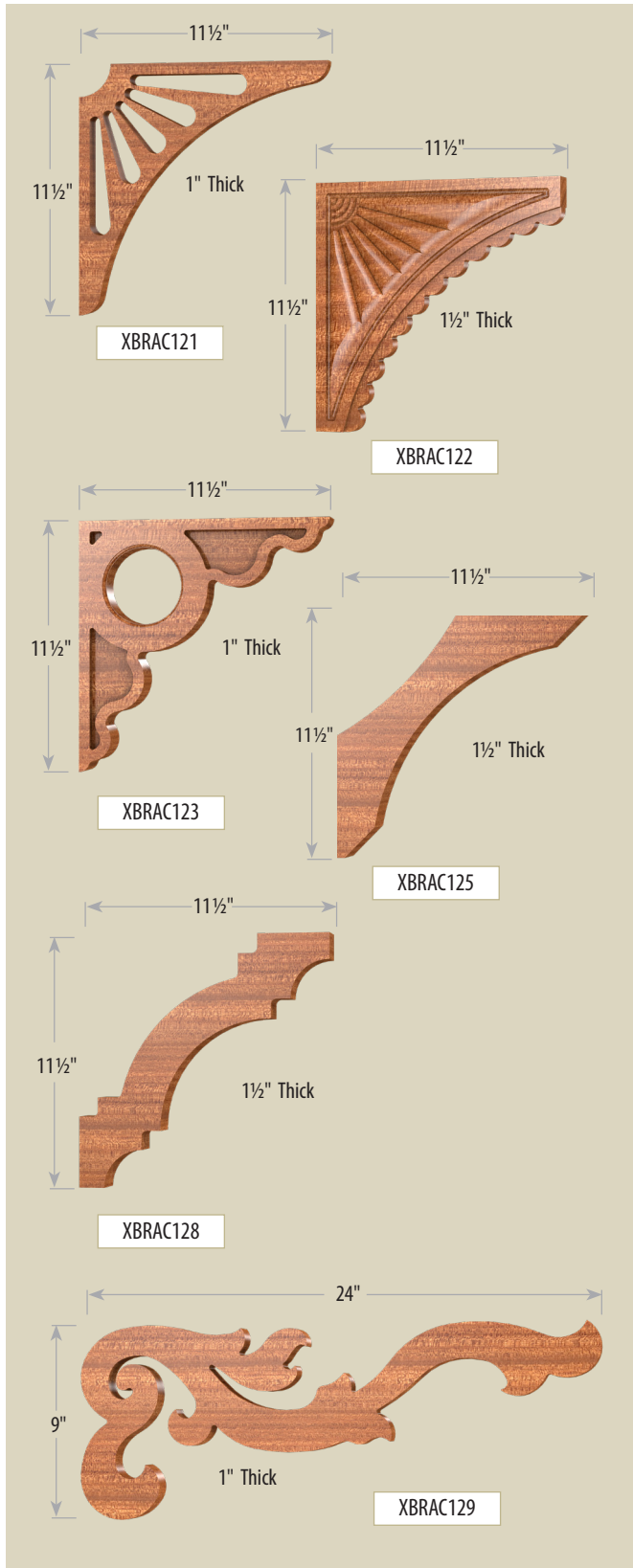

Exterior Spindles

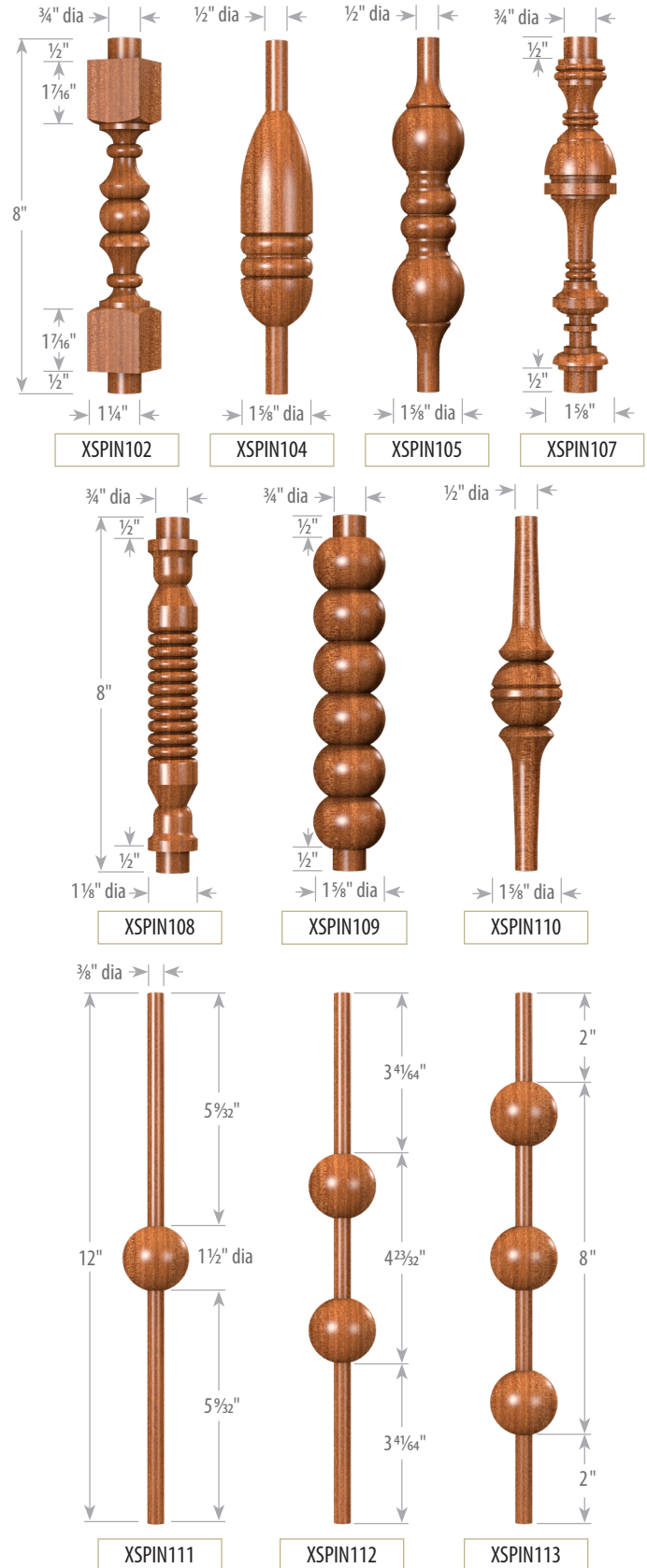

Exterior Products | These products will be made with exterior glue but no warranty for exterior use.
Our columns and posts have not been tested for their weight bearing ability and therefore are sold as NON-weight bearing.



OAK POINTE

WHERE TRADITION AND INNOVATION CREATE EXCELLENCE

96 NEW PACE ROAD
NEWCOMERSTOWN
OHIO 43832

P 740.498.9820

F 740.498.9821

GENERAL INQUIRY

INFO@STAIRPARTSANDMORE.COM

QUOTE REQUESTS

QUOTES@STAIRPARTSANDMORE.COM

SUBMIT ORDERS

ORDERS@STAIRPARTSANDMORE.COM

Connect with us on:

