

# Highland Series

◆ DIAMOND COLLECTION

STAIR PARTS • LEGS • COLUMNS



## Highland Series

The Highland Series is part of our **Diamond Collection**, designed and manufactured by Oak Pointe includes familiar & new products for stairways but with Oak Pointe's typical expanded options including parts for fireplaces, columns, kitchens and more. All components in this collection are for *interior use only*.

Highland Series  
DIAMOND COLLECTION

Ribbon 1 (RIB1)  
milling option  
shown



Kitchen Island Column



Pin Top Baluster



Bun Foot



Table Leg



Post to Post Newel



Fireplace Column

MADE IN THE USA ★ ★ ★

**Suggested Handrails:** To complement Highland Series stair parts. For more selections of flat bottom and plowed handrails, see pages 263-265 in our catalog Edition 3.0.



6210



6310



6400



6519



6710



6910

Newel Dimensions

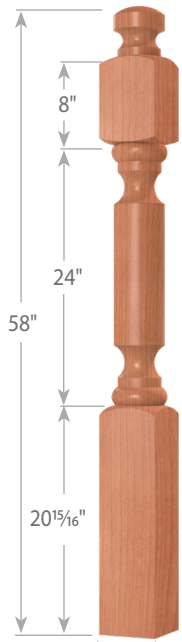

Post to Post Estate Newel  
3650-550

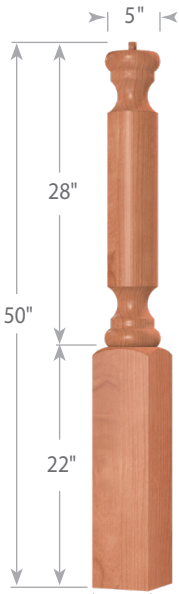

Pin Top Estate Newel  
3616-550

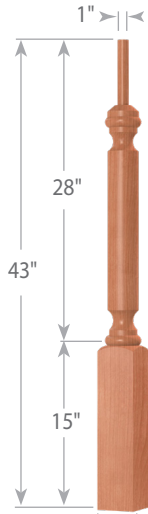

Pin Top Rake Newel  
3613-350

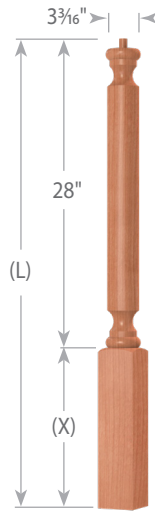

Pin Top Newel  
Model (L) (X)

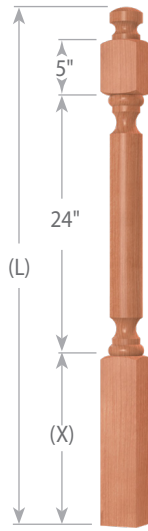

Post to Post Newel  
Model (L) (X)

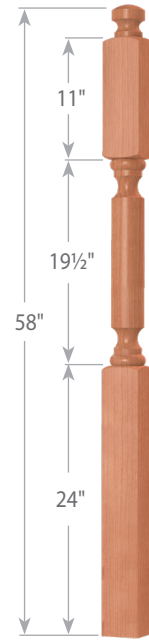

2nd Floor Landing Newel  
3645-350

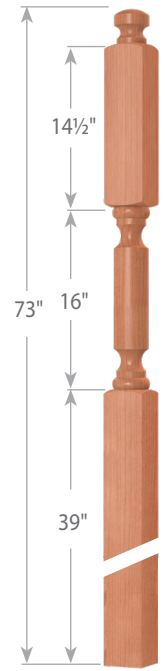

Intermediate Landing Newel  
3646-350

Model	(L)	(X)	Model	(L)	(X)
3610-350	43"	15"	3640-350	48"	15 1/2"
3614-350	50"	22"	3642-350	58"	25 1/2"
3615-350	58"	30"	3653-350	62"	29 1/2"
3617-350	65"	37"	3655-350	73"	40 1/2"
3618-350	73"	45"	3658-350	78"	45 1/2"

Post to Post Newels shown with Dome Top (DOM). See all Post Top options on pages 300-302 in our catalog Edition 3.0.

## Baluster Dimensions

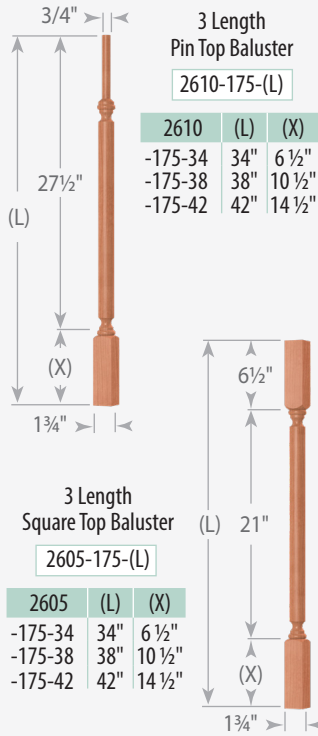

See page 22 in our catalog Edition 3.0 for 3 Length Baluster orientation on treads



### Wooden Dowel Pin

The bottom of each 3 length baluster is drilled and shipped with a loose wooden pin for installation. Optional steel dowel screws also available. Order #3076-100PK (pack of 100).

Milling Options	Barley 1	Barley 2	Corkscrew	Fluted	Reeded	Ribbon 1	Ribbon 2	Ribbon 3
Code	BAR1	BAR2	CS	F	R	RIB1	RIB2	RIB3

## 2610-175 Pin Top Balusters (1 3/4" wide)

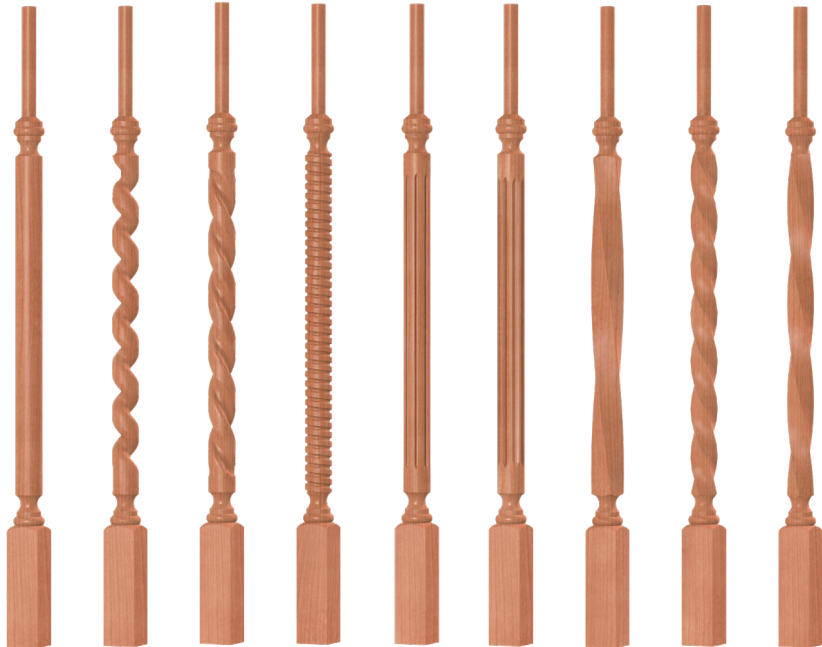

Plain -BAR1 -BAR2 -CS -F -R -RIB1 -RIB2 -RIB3

## 2605-175 Square Top Balusters (1 3/4" wide)

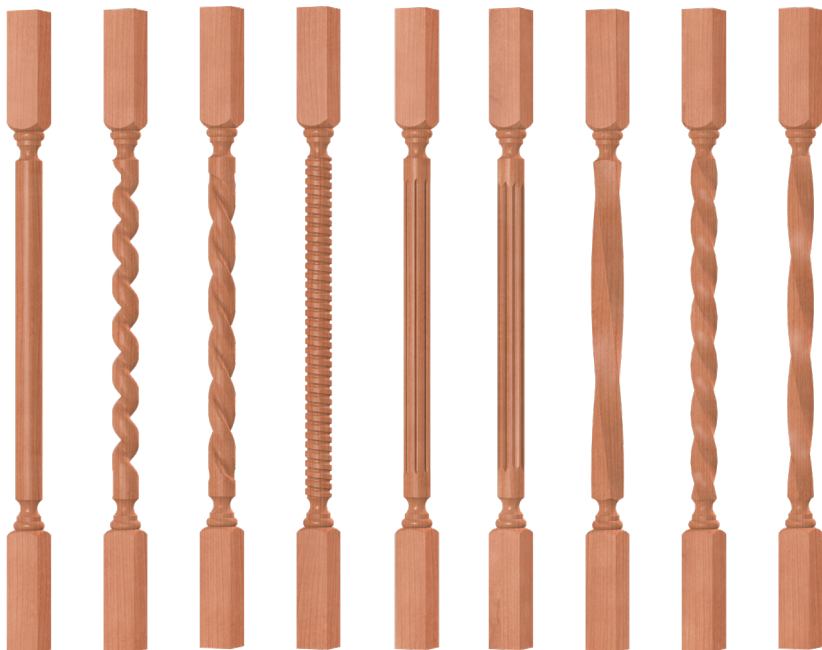

Plain -BAR1 -BAR2 -CS -F -R -RIB1 -RIB2 -RIB3

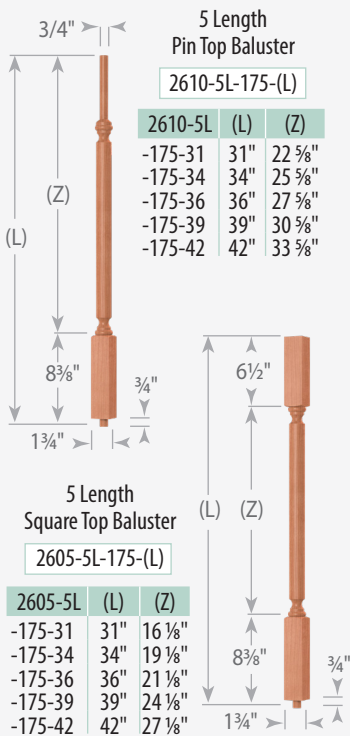

See page 22 in our catalog Edition 3.0 for 3 Length Baluster orientation on treads



Highland Series  
DIAMOND COLLECTION

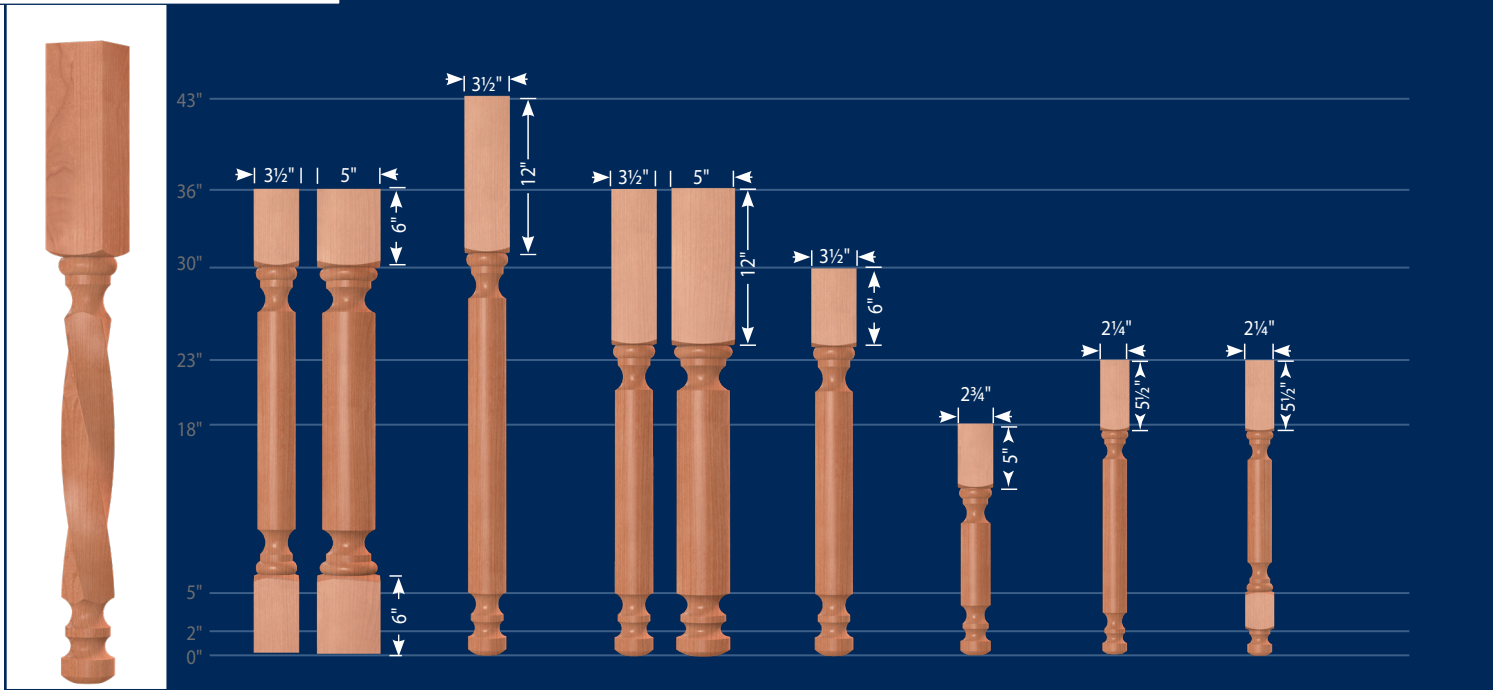

Island Leg Example 102605-350-RIB1	Island Column 12605-350 12605-500	Bar Leg (footed) 122605-350	Island Leg (footed) 102605-350 102605-500	Table Leg (footed) 92605-350	Coffee Table Leg (footed) 82605-275	End Table Leg (footed) 72605-225	End Table Leg (w/stretcher block) 62605-225
---------------------------------------	---	--------------------------------	---	---------------------------------	--	-------------------------------------	--

Bun Foot

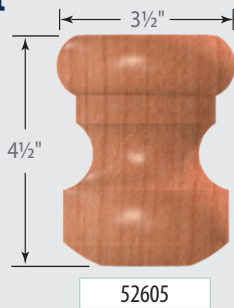

Highland Series Bun Foot

For more Bun Feet selections, see pages 298-299 in our catalog Edition 3.0.

MILLING OPTIONS	CODE	Island Column	Legs	Bun Feet	Interior Post	Fireplace Column	Decorative Column
Barley 1	BAR1	3	3		3	3	
Barley 2	BAR2	3	3		3	3	3 *
Corkscrew	CS	3	3		3	3	3
Fluted	F	3	3		3	3	3
Reeded	R	3	3		3	3	3
Ribbon 1	RIB1	3	3		3	3	
Ribbon 2	RIB2	3	3		3	3	
Ribbon 3	RIB3	3	3		3	3	
Ribbon 4	RIB4						3

\*Barley 2 (BAR2) milling option not available for Decorative Columns over 7 1/2" width

Columns, Legs and Bun Feet Milling Options

Milling Options Details									
	Name	Barley 1	Barley 2	Corkscrew	Fluted	Reeded	Ribbon 1	Ribbon 2	Ribbon 3
Code	BAR1	BAR2	CS	F	R	RIB1	RIB2	RIB3	RIB4

## Interior Posts

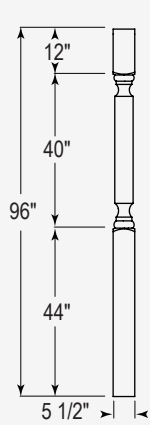

Standard post size is 5 1/2" wide and 96" high.



Interior Post Shown Plain

42605-550

Our columns and posts have not been tested for their weight bearing ability and therefore are sold as NON-weight bearing.

## Fireplace Columns

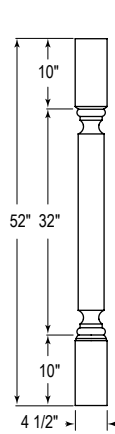

Top and bottom blocks are round



Fireplace Column Example

22605-450-BAR1

**Tuscan Base**  
used for Cap and Base (optional)



Model No. BASETUS450

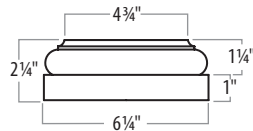

Fireplace Columns shown with Barley 1 milling option.

See pages 316-319 in our catalog Edition 3.0 for more Fireplace Columns

## Decorative Solid Round Columns

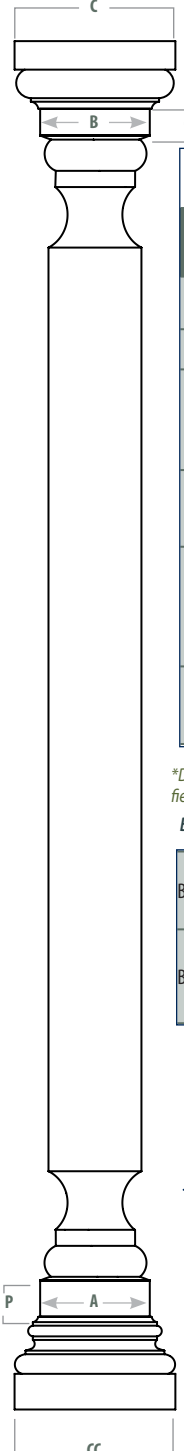

Decorative Solid Round Column Dimensions\*

Column Size	550	750	950
Bottom Dia. "A"	5 1/2"	7 1/2"	9 1/2"
Top Dia. "B"	5 1/2"	7 1/2"	9 1/2"
Round Bottom Block Height "P"	2"	2 3/8"	3 3/8"
Round Top Block Height "Q"	1 1/2"	2"	2 1/2"
Standard Lengths (including cap & base)	6' 7' 8'	6' 7' 8' 9' 10'	6'
Cap & Base Included	Attic Base with Tuscan Base for Cap		

\*Dimensions shown are after final field trimming of shaft bottom.

### Base/Cap Dimensions

Tuscan Base Bottom Square Width "C"	9"	11"	13"
Attic Base Bottom Square Width "CC"	9"	11"	13"



Tuscan Base used for Cap



Attic Base

See page 312 in our catalog Edition 3.0 for all Base and Cap dimensions

7 1/2" x 96"  
Highland Series Column  
with Cap and Attic Base  
Example

32605-750-96-CS

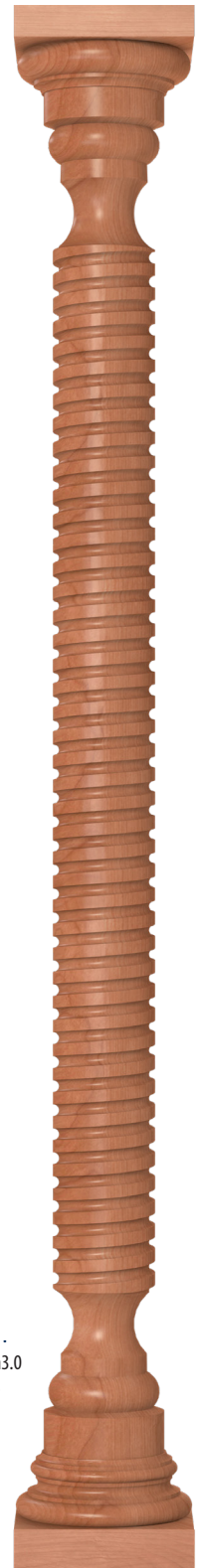

NOTE: These columns are manufactured from solid blanks with face and edge grain.

See pages 310-315 in our catalog Edition 3.0 for more Columns

# *Common to Extraordinary* Stair Parts, Columns and other Millwork

Stair Parts

Iron Balusters

Stainless Steel

Cable & Glass Systems

Table Legs, Pedestals & Bun Feet

Island & Fireplace Columns

Tapered & No Tapered Columns

Columns for any Application

Finials & Carvings

Corbels & Mouldings

Novelty Items & Store Fixtures

Custom & Large Turnings

Interior & Exterior Applications

... and MORE!



[www.StairPartsandMore.com](http://www.StairPartsandMore.com)

96 New Pace Road | Newcomerstown, Ohio 43832

P 740.498.9820 | F 740.498.9821

quotes@stairpartsandmore.com | orders@stairpartsandmore.com

Connect with us on:

