

Modern Metal Made Easy

PRICING COMPARISON





Contact Information

96 New Pace Rd.
Newcomerstown, OH 43832

P 740.498.9820
F 740.498.9821

Email

quotes@stairpartsandmore.com
orders@stairpartsandmore.com
info@stairpartsandmore.com

www.stairpartsandmore.com

Modern Metal Made Easy PRICING COMPARISON

Complete every metal stair or guardrail project, whether interior or exterior, residential or commercial, with Oak Pointe's comprehensive Modern Metal Collection. The Modern Metal Collection includes the Stainless Steel Full View, Square, Rectangle, and Round Series, as well as the Designer Metal Infills and Stainless Steel Cable Series.

Most projects can pair both wood and Stainless Steel newels and handrails. Infill offerings include glass components (*glass panels are not provided by Oak Pointe*), round bars/tubes, flat bars, cable with components, and metal panels.

For pricing and quotes regarding our Designer Metal Panels contact Oak Pointe.

With the Modern Metal Made Easy Pricing Comparison, Oak Pointe strives to empower customers to understand price points for various metal balustrade configurations. Prices included in this document are starting points. For a complete quote, customers should fill out the checklist(s) located on pages 7-10 and return to Oak Pointe Customer Service.

To review all wood and metal products, see Catalog Edition 3.0.

Configuration Description: Total List Price for a balustrade of a ten-rise stair with a four-foot balcony. Rake rail and balcony rail heights are figured at 36" and 38" respectively, with a rise of 7-1/2" and a run of 10".

Prices are subject to change.

The Oak Pointe Quote Process



Step 1: Complete the Modern Metal Made Easy Checklist or the Linear Metal Panel Checklist and email to an Oak Pointe Customer Service Team Member.

Checklists available on pages 7-10.



Step 3: After order is received, Oak Pointe's CAD Department will draw every section of the project. Measurements must be field-verified for accuracy. Upon final approval, fabrication will begin.



Step 2: Oak Pointe experts will design the system and provide a quote.

(All quotes are subject to final field measurements)



Step 4: Orders arrive ready to install and assemble per drawings. Metal newels will be fabricated & machined (*unless otherwise requested*).

Terminology

Infill – Product that fills the space between newels, treads, floor, deck, bottom rail, etc., and the bottom of the handrail. Oak Pointe offers metal panels, flat bars, round bars/tubes, glass clamps, and cable infill.

Infill Space – The horizontal space between newels. Also the vertical space from the top of the tread, floor, deck, or bottom rail to the bottom of the handrail.

Abbreviations

Bars	=	Solid
SS	=	Stainless Steel
Tubes	=	Hollow

Installation

Most building codes require spacing to be less than 4” between infill. On open stringer stairs with horizontal infill, the triangle created by the tread, riser, and bottom horizontal piece shall not allow a 6” sphere to pass.

Flat, Square, and Round Bars/Tubes – Spacing must not allow passage of a 4” sphere.

Cable – Installed no more than 3” between each run (3-1/8” on center for 1/8” diameter cable). Certain field conditions and longer runs may require tighter spacing.

NOTE: It is critical to check local building codes prior to starting any project.

How to Read this Document

Featured Components

Newel
(3) 4000-350 White Oak

Infill
 1/2” Tubes – SS





Handrail
 9200 White Oak

Baluster
 (2) 5360-175 White Oak

Installation Hardware

Total List Price: \$3,150

Additional Infill Options

	1/2” Bars – SS	+ \$769
	5/8” Tubes – SS	- \$4
	1/2” Tubes – Black	- \$510
	5/8” Tubes – Black	- \$397

Close-up view of additional Infill or Handrail.

This number indicates the number of Newels or Balusters that are quoted.

Installation Hardware includes all hardware required. **Stainless Steel Newel Mounting hardware is not included in the quote, nor are they provided by Oak Pointe.*

Total List Price indicates the total price to produce the balustrade featured.

Additional Infill or Handrail options with a (+) sign indicates an amount that should be added to the Total List Price.

\$3,150	Total List Price
+ \$769	1/2” Bars – SS
\$3,919	New Total List Price

Additional Infill or Handrail options with a (-) sign indicates an amount that should be subtracted from the Total List Price.

\$3,150	Total Price
- \$397	5/8” Tubes – Black
\$2,753	New Total List Price

Additional Information

- All systems as shown and quoted are for **interior use only** but can be quoted for exterior applications upon request. *Linear Metal Panels (pg. 2) are for interior use only.*
- Metal Newels will be fabricated to required lengths and machined unless otherwise requested.
- ***Mounting hardware for Stainless Steel Newels are NOT included in Total List Price.**
- **Items that require being cut in the field:** Stainless Steel handrail, bars/tubes, and cable, and wood handrail.
- Wood Newel(s) are cut to length and bored in the field (*machining by Oak Pointe may be requested*).
- Wood components priced in White Oak; prices vary by species.

01

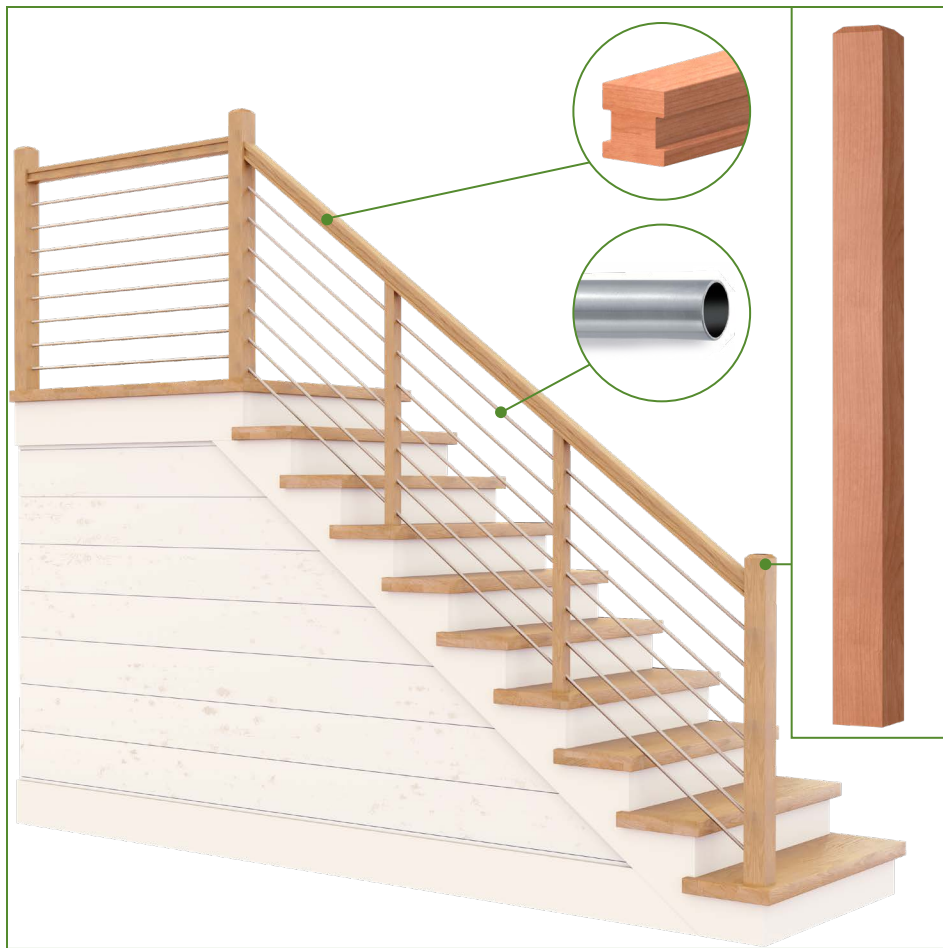

Featured Components

Newel
(3) 4000-350 White Oak

Infill
1/2" Tubes – SS



Handrail
9200 White Oak

Baluster
(2) 5360-175 White Oak

Installation Hardware

Total List Price: **\$3,150**

Additional Infill Options

	1/2" Bars – SS	+ \$769
	5/8" Tubes – SS	- \$4
	1/2" Tubes – Black	- \$510
	5/8" Tubes – Black	- \$397

02

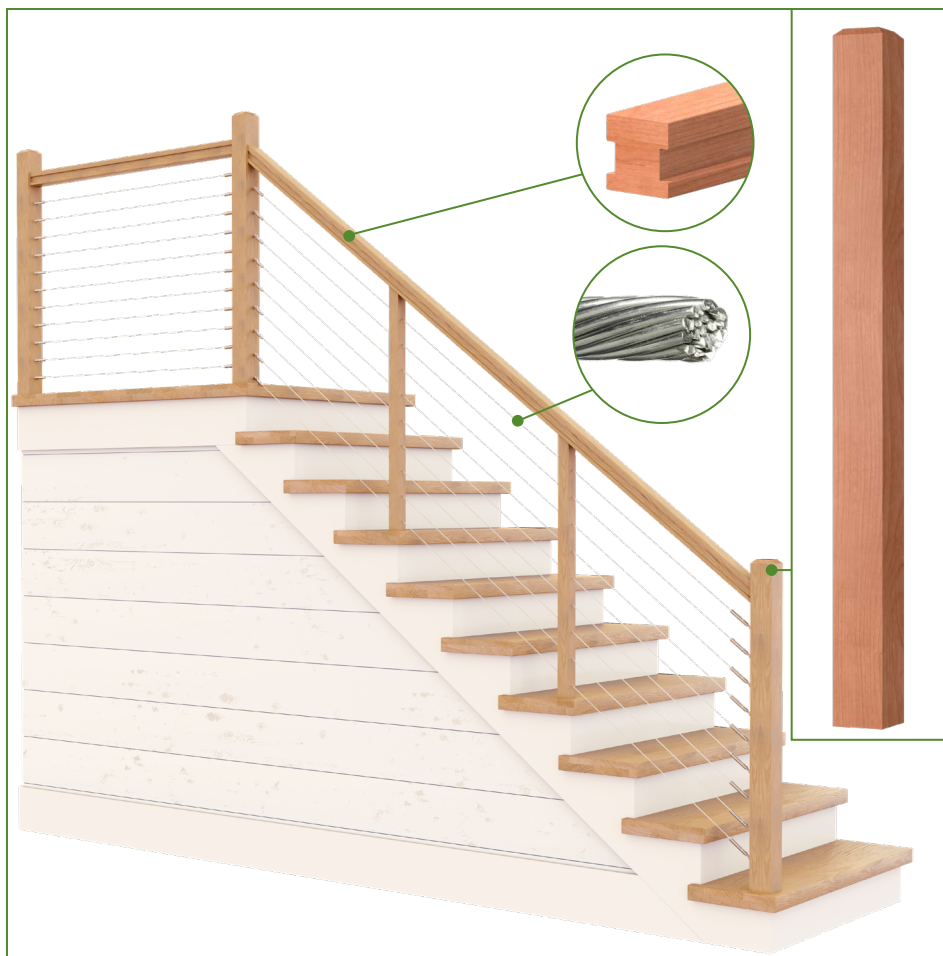

Featured Components

Newel
(3) 4000-350 White Oak

Infill
1/8" Cable

Handrail
9200 White Oak

Baluster
(2) 5360-175 White Oak

Installation Hardware

Total List Price: **\$4,762**

Additional Infill Options

	3/16" Cable	+ \$176
--	-------------	---------

03

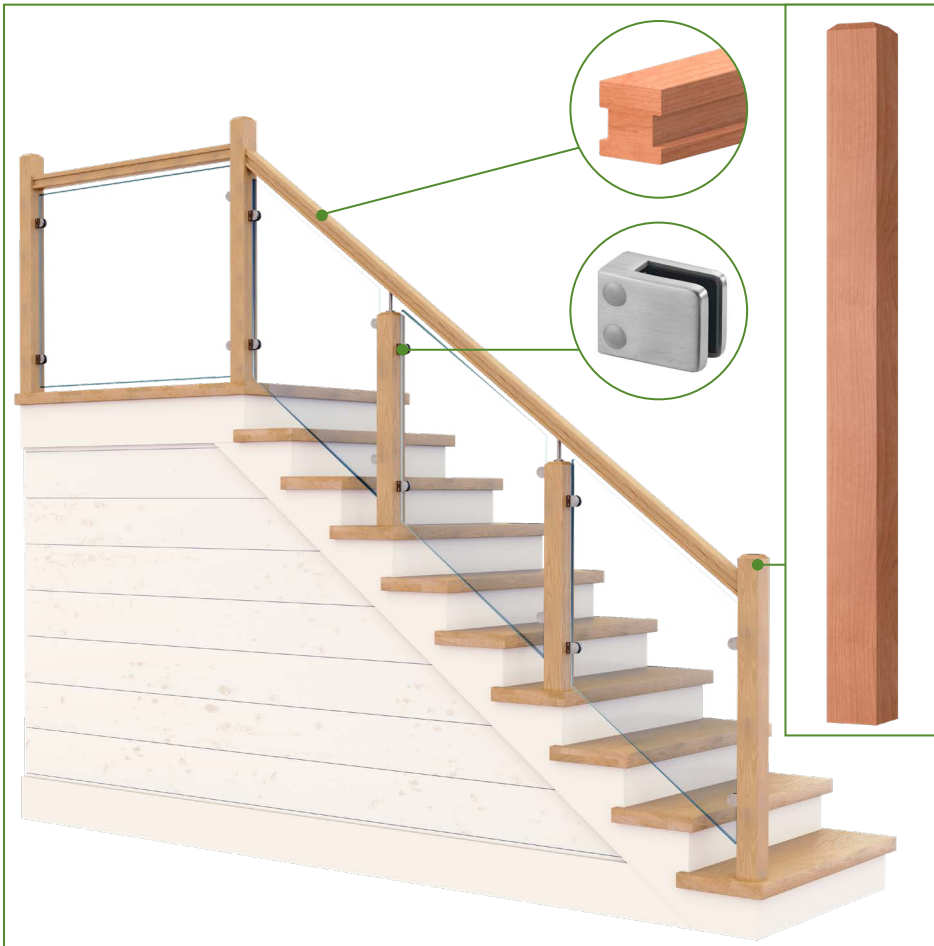

Featured Components

Newel

- (3) 4000-350 White Oak
- (2) 4000-350 White Oak w/Top Mount Bracket

Infill Hardware

Glass Clamps

Handrail

9200 White Oak

Installation Hardware

Total List Price: **\$3,506**

NOTE: *Glass Panels are not provided by Oak Pointe, we suggest hiring a local glass company to measure and cut glass.*

04



Featured Components

Newel

- (3) 4000-350 White Oak

Infill

Linear Metal Panels – Black

Handrail

9200 White Oak

Mounting Newels

- (4) LMMN-L2-47 – Black

Installation Hardware

Total List Price: **\$6,104**

NOTE: *Linear Metal Panels are for interior use only.*

05

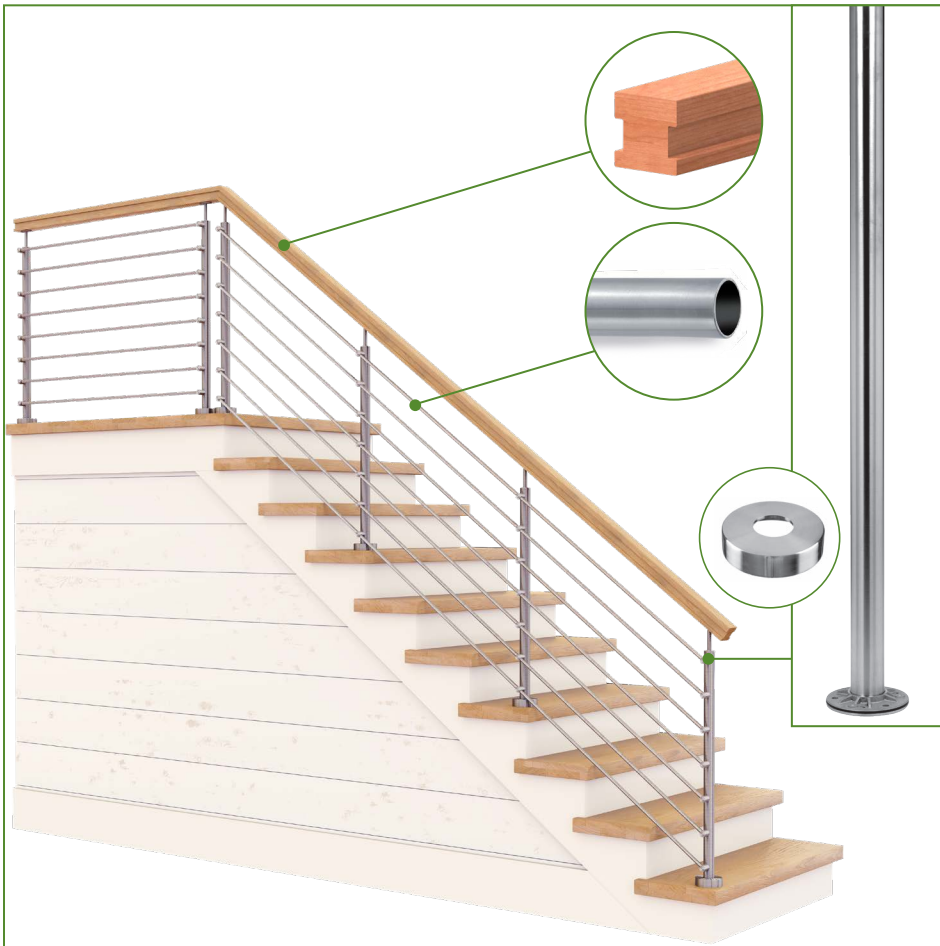

Featured Components

Newel & Maching
(6) 1.5" Round – SS

Infill
1/2" Tubes – SS

Handrail
9200 White Oak

***Installation Hardware**

Total List Price: **\$6,526**

 **Additional Infill Options**
1/2" Bars – SS + \$770

 **Additional Handrail Options**
1.5" Round – SS + \$21

06

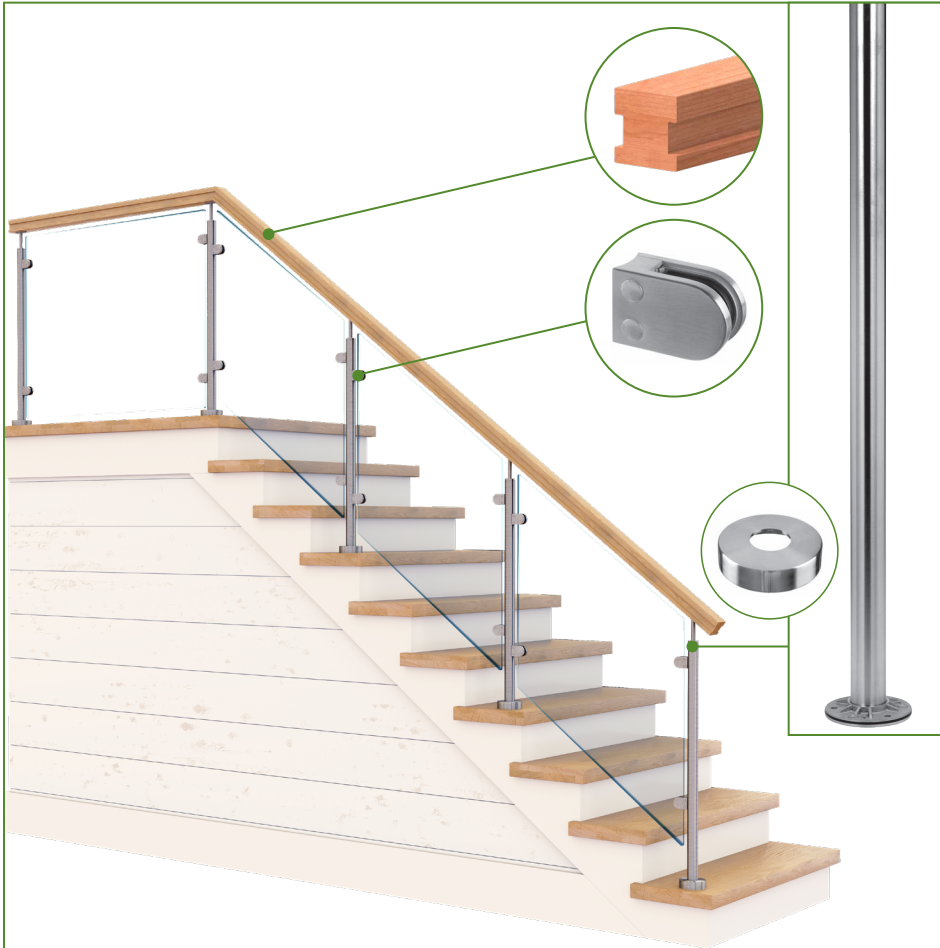

Featured Components

Newel & Maching
(5) 1.5" Round – SS

Infill Hardware
Glass Clamps

Handrail
9200 White Oak

***Installation Hardware**

Total List Price: **\$4,546**

NOTE: *Glass Panels are not provided by Oak Pointe, we suggest hiring a local glass company to measure and cut glass.*

 **Additional Handrail Options**
1.5" Round – SS + \$21

07

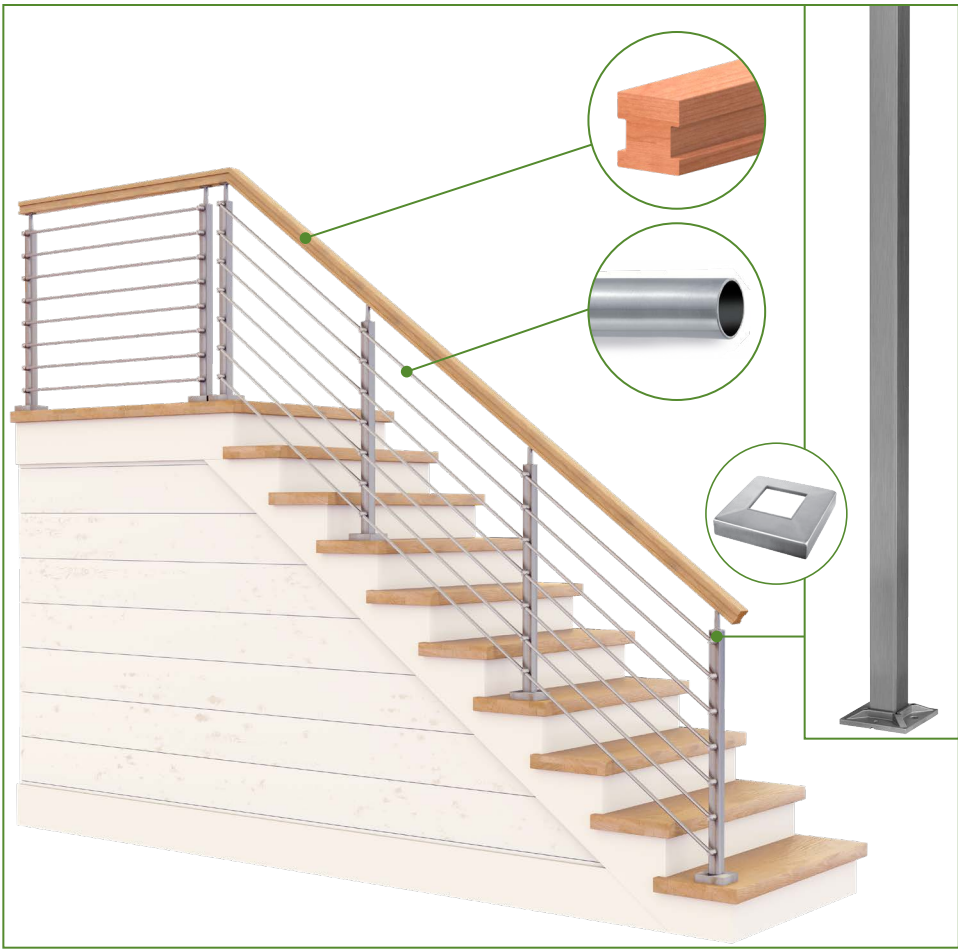

Featured Components

Newel & Maching
(6) 1.57" Square – SS

Infill
1/2" Tubes – SS

Handrail
9200 White Oak

***Installation Hardware**

Total List Price: **\$6,595**

 **Additional Infill Options**
1/2" Bars – SS + \$770

 **Additional Handrail Options**
1.5" Round – SS + \$41

 1.57" Square – SS + \$301

08

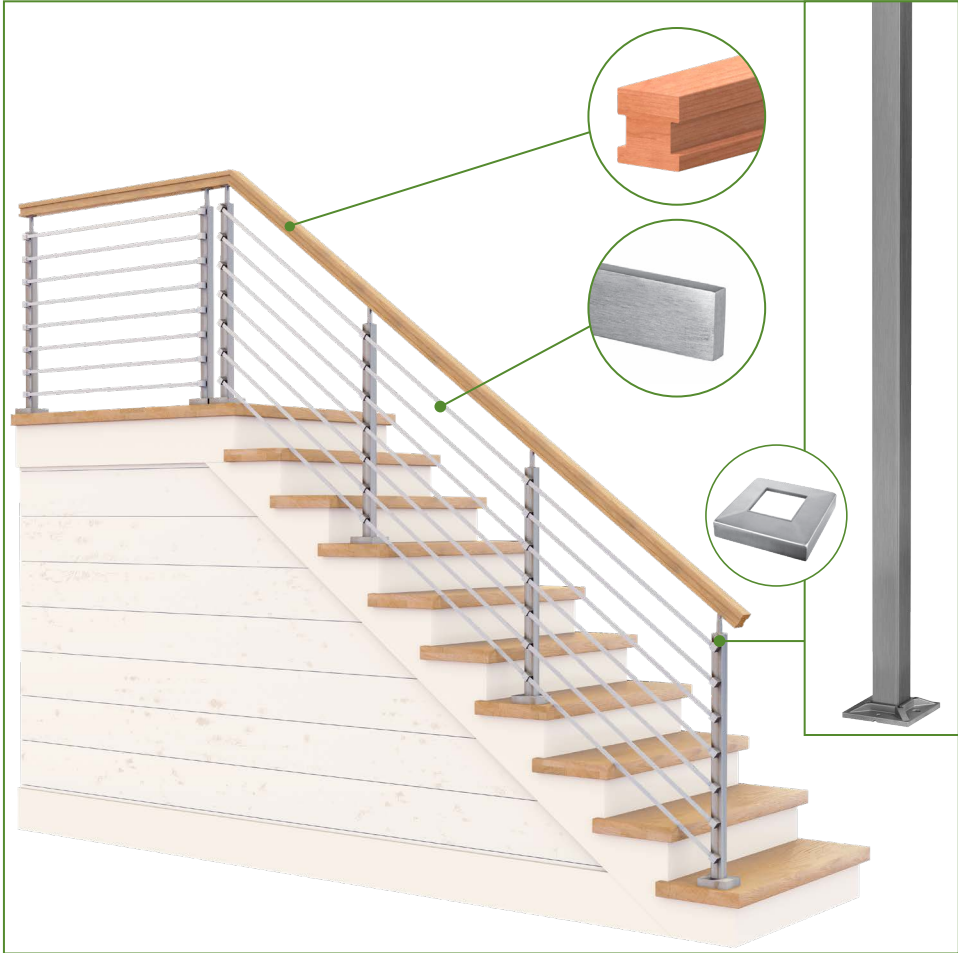

Featured Components

Newel & Maching
(6) 1.57" Square – SS

Infill
Flat Bar

Handrail
9200 White Oak

***Installation Hardware**

Total List Price: **\$7,427**

 **Additional Handrail Options**
1.5" Round – SS + \$41

 1.57" Square – SS + \$301

09

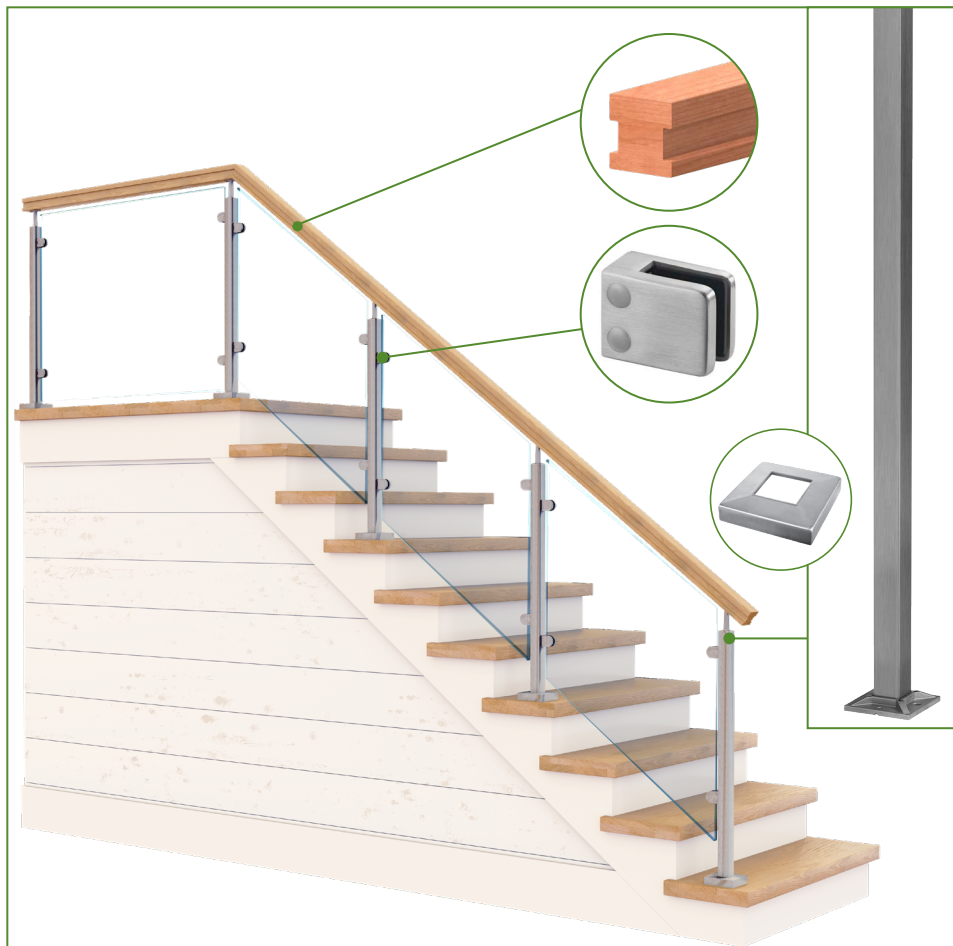

Featured Components

Newel & Machining
(5) 1.57" Square – SS

Infill Hardware
Glass Clamps

Handrail
9200 White Oak

***Installation Hardware**

Total List Price: **\$4,855**

NOTE: *Glass Panels are not provided by Oak Pointe, we suggest hiring a local glass company to measure and cut glass.*



Additional Handrail Options
1.5" Round – SS + \$41



1.57" Square – SS + \$301

10

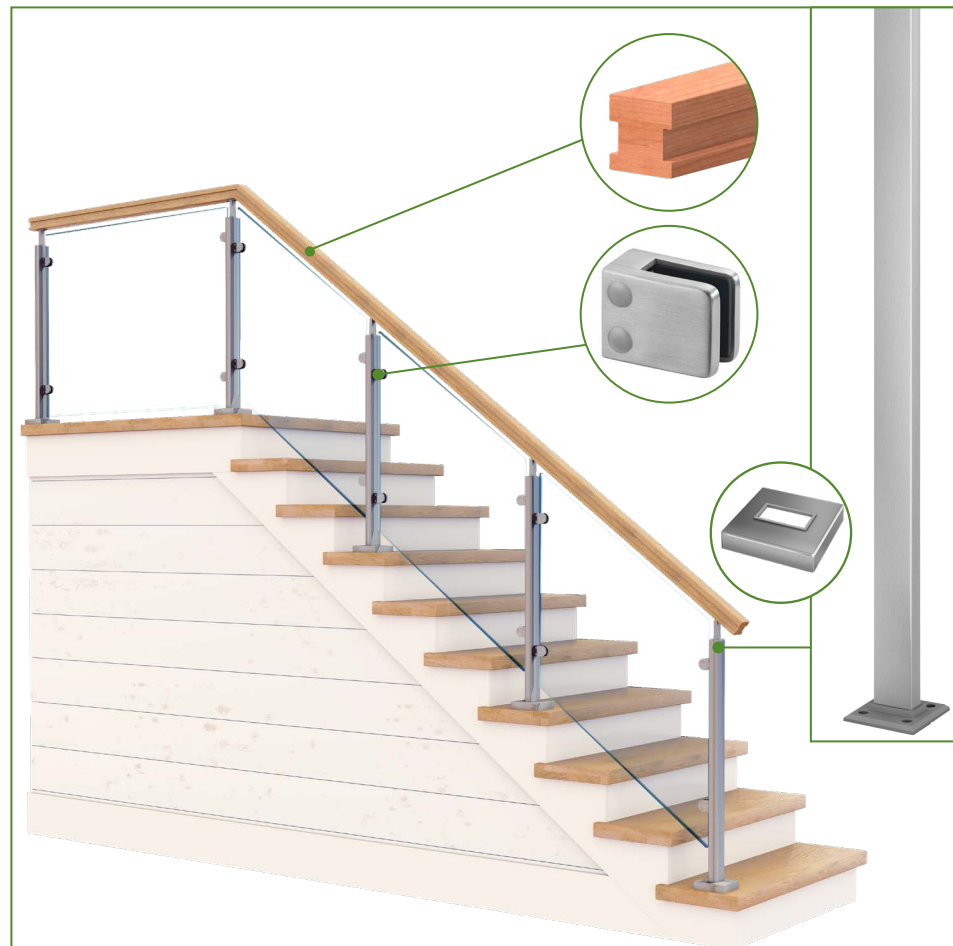

Featured Components

Newel & Machining
(5) 2.36" X 1.18" Rectangle – SS

Infill Hardware
Glass Clamps

Handrail
9200 White Oak

***Installation Hardware**

Total List Price: **\$6,243**

NOTE: *Glass Panels are not provided by Oak Pointe, we suggest hiring a local glass company to measure and cut glass.*



Additional Handrail Options
1.5" Round – SS - \$116



2.36" x .78" Rectangle – SS + \$1,012

11

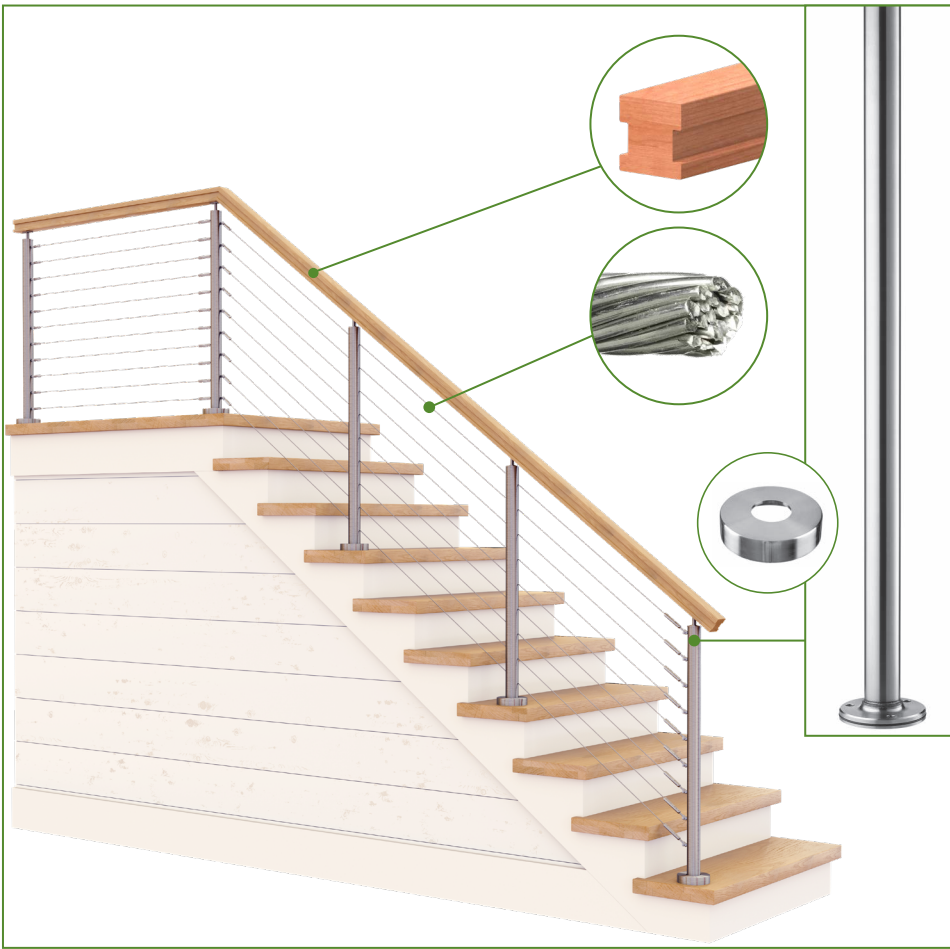

Featured Components

Newel & Maching
(5) 1.9" Round – SS

Infill
1/8" Cable

Handrail
9200 White Oak

***Installation Hardware**

Total List Price: **\$9,773**

Additional Infill Options
3/16" Cable + \$178

 **Additional Handrail Options**
1.5" Round – SS - \$7

12

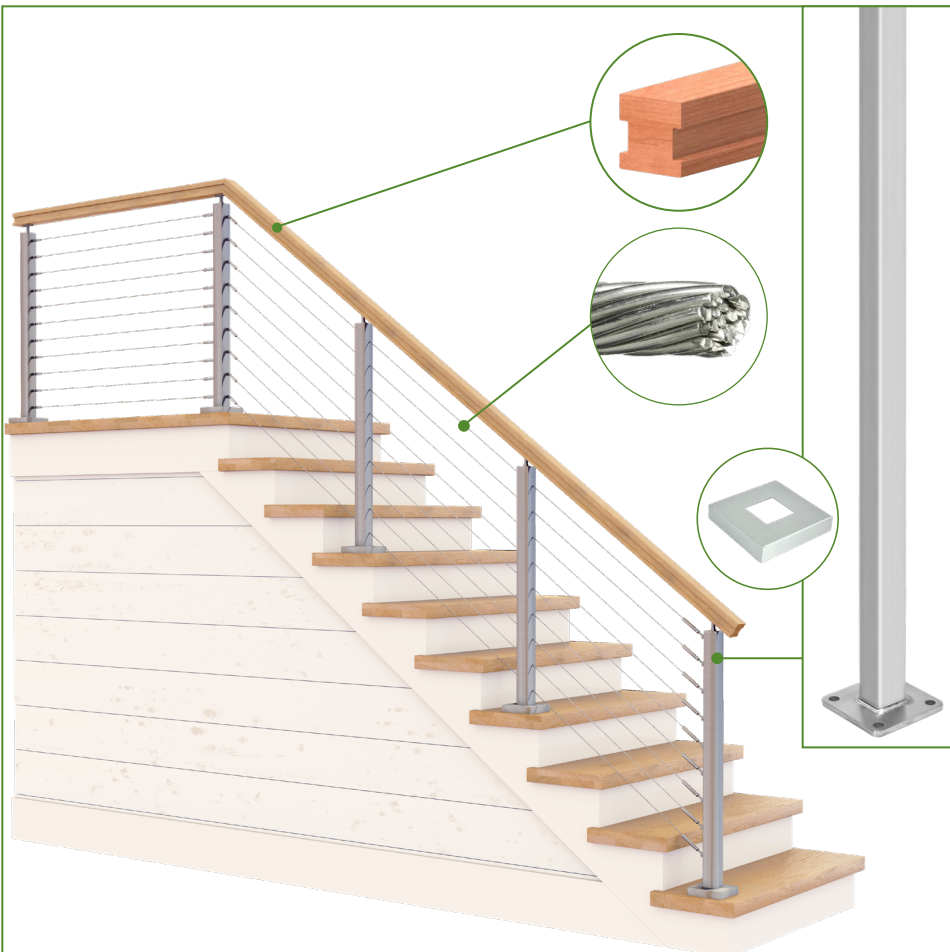

Featured Components

Newel & Maching
(5) 2" Square – SS

Infill
1/8" Cable

Handrail
9200 White Oak

***Installation Hardware**

Total List Price: **\$9,672**

Additional Infill Options
3/16" Cable + \$178

 **Additional Handrail Options**
1.5" Round – SS + \$125

 **Additional Handrail Options**
1.57" Square – SS + \$408

Modern Metal Made Easy Quote Checklist

96 New Pace Rd. | Newcomerstown, OH 43832 | P 740.498.9820
 Submit quote requests: quotes@stairpartsandmore.com

Name: _____
 Company: _____
 Store Location: _____
 Job Name: _____
 Date: _____ Phone #: _____

1 Drawings:
 Provide the ***Plan View** (architect drawings) or **Sketch** of the stairway or deck with dimensions. Include Elevation View if available.

Attachments Included:

- *Plan View or Sketch (Required)
- Elevation View
- Additional Photos

2 Location: Select one

- Interior Use
- Exterior Use

3 Stringer:

- Open Stringer
- Closed Stringer (Kneewall) Width: _____
See image in box 4.

4 Kneewall:

- Yes
- Height: _____
- No

*Not required for quote to be completed.

NOTE: When measuring the height of the kneewall measure from the top of the tread nosing.

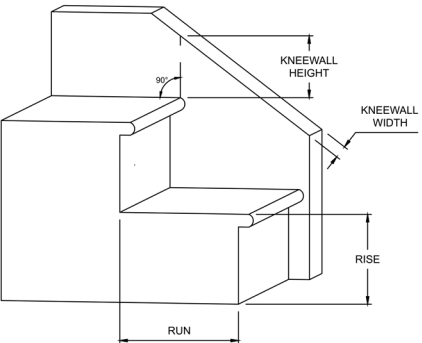

5 Rise and Run:
See image in box 4.

- Rise: _____
- Run: _____

*Not required for quote to be completed.

6 Newels:

- 1. Stainless Steel**
 - a. Round – Size Options
 - 1.5" (not for cable)
 - 1.9"
 - b. Square – Size Options
 - 1.57" (not for cable)
 - 2"
 - c. Rectangular
- 2. Aluminum 2" Square with Powder Coated Finish** (cable only)
See our Catalog Edition 3.0 pg. 194 or Modern Metal Collection pg. 8. More options available at ralcolor.com.
- NOTE:** All Stainless Steel or Aluminum Newels will be quoted for machining by Oak Pointe and will arrive to the job site ready for installation unless otherwise requested.
- 3. Wood** (must be minimum of 3.5" square for cable systems)
 - a. Model Number: _____
OR Sketch/Photo for Custom Style
 - b. Wood Species:
 - Option 1: _____
 - Option 2: _____
- 4. Mounting** (see image to the right)
 - a. Fascia Mount
 - b. Top/Surface Mount

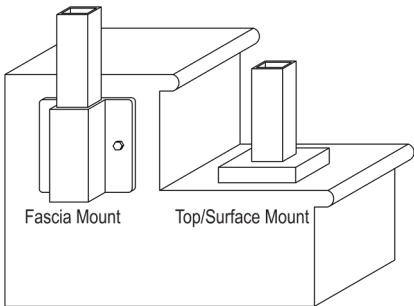

7 Handrail:

1. Stainless Steel

a. Round – Size Options

- 1.5"
- 1.9"

b. Square – Size Options

- 1.57"
- 2" (no fittings available)

c. Rectangular – Size Options

- 2.36" W x .78" H
- 2.36" W x 1.18" H (no fittings available)

2. Wood

a. Model Number: _____ **OR** Sketch/Photo for Custom Style

b. Wood Species:

Option 1: _____ Option 2: _____

3. Rake & Level

Minimum Rake Height: _____

Minimum Level Height: _____

IMPORTANT: Provide the dimensions of your handrail
(unless Oak Pointe is providing your handrail).

Height: _____

Bottom Flat Width: _____

Diameter: _____

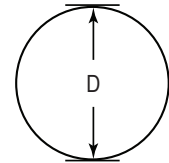
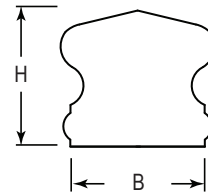

8 Infill:

1. Round Bar/Tubes

a. 1/2" Solid (Stainless Steel Only)

b. 1/2" Hollow – Color Options

- Stainless Steel
- Black

c. 5/8" Hollow – Color Options

- Stainless Steel
- Black

2. Flat Bar (not for round Newels)

3. Cable – Size Options

- 1/8"
- 3/16"

4. Glass Clamps

(Glass not provided by Oak Pointe)

Glass Thickness: _____

5. Designer Metal Panels

IMPORTANT: If there is a bottom rail, infill height is needed.

(Measure from the bottom of the top rail to the top of the bottom rail.)

Infill Height: _____

9 Cable Braces:

1. Stainless Steel

2. Aluminum (not recommended for interior use)

3. Wood Cable Braces

(Recommended: Catalog Edition 3.0 pg. 136-137)

- 5060 – 1.25"
- 5350 – 1.75"

NOTE: Cable needs to be supported a minimum of every 48". Braces may be used with Flat Bottom Rails, but braces with round rails are not available at this time.

10 Custom Powder Coating

See our catalogs Edition 3.0 pg.194 or Modern Metal Collection pg. 8 – **more options available at ralcolor.com.**

Color Choice: _____

Select component(s) to have Powder Coated.

- Newels
- Infill (not available for cable or fittings)
- Handrail
- Cable Braces

Linear Metal Panels Quote Checklist

96 New Pace Rd. | Newcomerstown, OH 43832 | P 740.498.9820
 Submit quote requests: quotes@stairpartsandmore.com

Name: _____
 Company: _____
 Store Location: _____
 Job Name: _____
 Date: _____ Phone #: _____

1

Drawings:
 Provide the ***Plan View** (architect drawings) or **Sketch** of the stairway or deck with dimensions. Include Elevation View if available.

Attachments Included:

- *Plan View or Sketch** (Required)
- Elevation View
- Additional Photos

2

Location:
INTERIOR USE ONLY

3

Stringer:

- Open Stringer
- Closed Stringer (Kneewall) Width: _____
See image in box 4.

4

Kneewall: REQUIRED

- Yes
- Height: _____
- No

NOTE: When measuring the height of the kneewall measure from the top of the tread nosing.

5

Rise and Run:
See image in box 4.

- Rise: _____
- Run: _____

NOTE: The finished Rise & Run determine if standard rake angle panels will work. If there is a variance in the Rise & Run of your treads, list each.

6

First Newel:
 Choose Newels or Handrail (view our Catalog Edition 3.0 pg. 234 or Modern Metal Collection pg. 48).

- 1. Wood**
 - a. Model Number: _____ **OR** Sketch/Photo for Custom Style
 - b. Wood Species:
 - Option 1: _____
 - Option 2: _____
- 2. Metal** (Metal Newels will be either Mounting and/or Spacer Newels as required.)
- 3. Wood Rail** (see box 9)

7 Other Newels:

1. Wood

a. Model Number: _____ **OR** Sketch/Photo for Custom Style

b. Wood Species:

Option 1: _____

Option 2: _____

2. Metal *(Metal Newels will be either Mounting and/or Spacer Newels as required.)*

8 Preferred: Gap / Spacing

1. Between Panels

2. Between Newels and Panels

3. Between Wall and Panels

4. Between Bottom of Panels and Floor or Kneewall

5. Between Top of Panels and Handrail

6. No Gap/Spacing *(custom panels may be required)*

9 Handrail:

1. Wood

a. Model Number: _____ **OR** Sketch/Photo for Custom Style

b. Wood Species:

Option 1: _____ Option 2: _____

2. Rake & Level

Minimum Rake Height: _____

Minimum Level Height: _____

IMPORTANT: Provide the dimensions of your handrail
(unless Oak Pointe is providing your handrail).

Height: _____

Bottom Flat Width: _____

Rail width must be greater than 1.5"

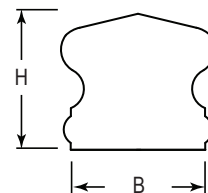

10 Color:

1. Black – STANDARD

2. Raw

3. Custom Powder Coated

Color Choice: _____

*See our Catalog Edition 3.0 pg. 194 or Modern Metal Collection pg. 8.
More options available at ralcolor.com.*

11 Miscellaneous:

1. All panels will be horizontal unless otherwise requested.

2. Installation

a. **Standard – Flush Mount:** Panels are flush to the bottom of the handrails.

b. **Plowed Rails** *(Additional Cost)*

Common to Extraordinary Stair Parts, Columns, and other Millwork

Stair Parts

Iron Balusters

Stainless Steel

Cable & Glass Systems

Table Legs, Pedestals & Bun Feet

Island & Fireplace Columns

Tapered & Non Tapered Columns

Columns for any Application

Finials & Carvings

Corbels & Mouldings

Novelty Items & Store Fixtures

Custom & Large Turnings

Interior & Exterior Applications

... and MORE!



www.StairPartsandMore.com

96 New Pace Rd. | Newcomerstown, Ohio 43832

P 740.498.9820 | F 740.498.9821

quotes@stairpartsandmore.com | orders@stairpartsandmore.com

Connect with us on:

